

TD Pilot

User's Manual



User's Manual TD Pilot

Version 1.0.8

2023-06-09

All rights reserved.

Copyright © Tobii Dynavox AB (publ)

No part of this document may be reproduced, stored in a retrieval system, or transmitted in any form, by any means (electronic, photocopying, recording, or otherwise) without the prior written permission of the publisher.

Copyright protection claimed includes all forms and matters of copyrightable material and information allowed by statutory or judicial law or hereafter granted, including without limitation, material generated from the software programs which are displayed on the screen such as screen displays, menus, etc.

The information contained in this document is proprietary to Tobii Dynavox. Any reproduction in part or whole without prior written authorization by Tobii Dynavox is prohibited.

Products that are referred to in this document may be either trademarks and/or registered trademarks of the respective owners. The publisher and the author make no claim to these trademarks.

While every precaution has been taken in the preparation of this document, the publisher and the author assume no responsibility for errors or omissions, or for damages resulting from the use of information contained in this document or from the use of programs and source code that may accompany it. In no event shall the publisher and the author be liable for any loss of profit or any other commercial damage caused or alleged to have been caused directly or indirectly by this document.

Content subject to change without notice.

Please check Tobii Dynavox website.

www.TobiiDynavox.com for updated versions of this document.

Contact Information:

Tobii Dynavox AB
Karlsrovägen 2D
182 53 Danderyd
Sweden

+46 8 663 69 90

Tobii Dynavox LLC
2100 Wharton Street, Suite 400
Pittsburgh, PA 15203
USA

+1-800-344-1778

Tobii Dynavox Ltd.
Sheffield Technology Parks
Cooper Buildings
Arundel Street
Sheffield S1 2NS
United Kingdom

+46 8 663 69 90

Tobii Dynavox (Suzhou) Co. Ltd
Unit 11/12, Floor 3, Building B, No.5 Xinghan Street, SIP,
Suzhou
P.R.China 215021

+86 512 69362880



Table of Contents

1	Introduction.....	6
1.1	Explanation of Admonitions	6
1.2	Symbols and Markings.....	6
1.2.1	Product Label	8
1.3	Intended Use.....	9
1.4	Package Contents.....	9
1.4.1	TD Pilot	9
2	Safety.....	11
2.1	Avoiding Hearing Damage	12
2.2	Power Supply and Batteries.....	12
2.3	Mounting	13
2.4	Emergency.....	13
2.5	Infrared.....	13
2.6	Epilepsy	13
2.7	Electricity.....	13
2.8	Software.....	14
2.9	Child Safety.....	14
2.10	Eye Tracking	14
2.11	Third Party	14
3	Overview of the TD Pilot	15
3.1	Key Features.....	15
3.2	Product Layout.....	15
3.2.1	Ports, Sensors and Device Buttons	15
4	Batteries in the TD Pilot.....	17
4.1	Batteries.....	17
4.2	Charging the TD Pilot.....	17
4.2.1	The Status LED Behavior.....	17
4.3	Changing the Battery	17
5	Using the TD Pilot.....	18
5.1	Starting the TD Pilot.....	18
5.2	Shutting Down the TD Pilot.....	18
5.3	First Start Up.....	18
5.4	Setting Up Eye Gaze Access.....	18
5.4.1	Configuring the iPadOS for Gaze Access	18
5.4.2	Setting up AssistiveTouch.....	19
5.4.3	Customizing the AssistiveTouch Menu	19
5.4.4	Configuring Dwell Control	20
5.4.5	Waking and Unlocking Your iPad	21
5.5	Using Apps with AssistiveTouch (if Applicable)	21
5.5.1	Accessing the AssistiveTouch Menu.....	22

5.5.2	Taking a Break When Needed	23
5.5.3	Using the iPad with your Eyes	23
5.5.4	Moving the AssistiveTouch Button	23
5.5.5	Choosing Appropriate Apps	24
5.6	Using Eye tracking	24
5.6.1	Positioning.....	24
5.6.2	Tips for Outdoor Usage.....	25
5.6.3	Track Box.....	25
5.6.4	Track Status.....	26
5.7	Using the Adjustable Stand.....	26
5.8	Using the Partner Window	27
5.9	Adjusting the Volume	27
6	TD CoPilot	28
6.1	Calibration	28
6.1.1	Start Calibration	28
6.2	Accuracy	28
6.3	Settings	29
6.3.1	Calibration	29
6.3.2	Battery	30
6.3.3	Assistive Touch	31
6.3.4	Help	31
6.3.5	About	32
7	Product Care	33
7.1	Temperature & Humidity	33
7.1.1	General Use - Operating Temperature	33
7.1.2	Transportation and Storage	33
7.2	Cleaning of the Device.....	33
7.3	Placement.....	33
7.4	Transporting the TD Pilot Device	33
7.5	Disposing of Batteries	34
7.6	Disposing of the Device	34
Appendix		
A	Support, Warranty, Training Resources and Trouble-shooting.....	35
A1	Customer Support.....	35
A2	Warranty	35
A3	Training Resources.....	35
A4	Trouble-shooting Guide	35
A4.1	If the TD Pilot does not Power up	35
A4.2	How do I carry out a Power Reset on the TD Pilot?.....	36
A4.3	How can I tell if the TD Pilot Base is Connected to the iPadOS Device?	36
A4.4	Refining Eye Gaze	36
B	Compliance Information	38
B1	FCC Statement	38
B1.1	For P15B Equipment.....	38
B1.2	For Portable Devices.....	38

B2	CE Statement.....	38
B3	Directives and Standards.....	38
C	Status LED Information.....	40
D	Technical Specifications.....	41
D1	Standard TD Pilot.....	41
D2	Device Power Adapter	41
D3	Battery pack	42
D4	Eye Tracker.....	42
E	Guidance and Manufacturer’s Declaration	44
F	Approved Accessories.....	46
G	Local Certification Partners.....	47

1 Introduction

Thank you for purchasing a TD Pilot device from Tobii Dynavox!

To ensure the optimal performance of this product, please take the time to read this manual carefully.

The TD Pilot device is available in one size.

TD Pilot is a dedicated speech generating device that has the ability to add eye tracking as an accessory to the device.

The TD Pilot is a Eye tracking device with an Apple iPad 12.9" running iPadOS version 15.1 or later.

This User's Manual covers:

- The TD Pilot device.

This User's Manual does not cover:

- The Eye tracking functions.

1.1 Explanation of Admonitions

In this manual we use five (5) levels of admonitions as follows:



The Note symbol is used for notifying the user of something important or of something that needs special attention.



The Tips symbol is used for notifying the user of something they might not have thought of.



The Caution symbol is used to inform of something that could cause harm to, or malfunction of, the equipment.





The Warning symbol is used to inform of something in which there is a conceivable risk of harm to the user if the Warning is ignored.

































The High Volume symbol is used to inform of something that can cause damage to hearing.

1.2 Symbols and Markings

This section provides information about the symbols that are used on the TD Pilot, its accessories or packaging.

Symbol or Markings	Description
	Stand-by.
SW1	3.5 mm Switch port 1.
SW2	3.5 mm Switch port 2.
	Power Connector.
	Head phone jack 3.5 mm.

Symbol or Markings	Description
	Dispose of in accordance with your country's requirements.
	CE is the abbreviation of the European Communities and this mark tells customs officials in the European Union that the product complies with one or more of the EC Directives.
	The UKCA (UK Conformity Assessed) marking is a UK product marking that is used for goods being placed on the market in Great Britain (England, Wales and Scotland). It covers most goods which previously required the CE marking.
	This mark is a certification mark employed on electronic products manufactured or sold in the United States which certifies that the electromagnetic interference from the device is under limits approved by the Federal Communications Commission.
	Mark representing compliance with regulatory requirements in Russia, Kazakhstan, and Belarus.
	The Mark indicates compliance of electronic appliances such as IT and Audio/Video Equipment with NOM (Normas Oficiales Mexicanas) standards for safety in Mexico.
	Japanese certification for electrical/electronic appliances and components.
	The Technical Conformity Mark is a proof that the radio equipment conforms to the technical regulations specified in the Radio Law in Japan.
	Conforms to relevant Japanese EMC requirements.
	IC is the abbreviation of the Industry Canada and this mark tells customs officials in Canada that the product complies with one or more of the Canadian standards.
	UL Classification Marks for Canada and the United States.
	Recognized component mark for Canada and the United States.
	Follow Instructions for Use.
	Consult User's Manual.
	Recyclable material.
	Recyclable material in Taiwan.

Symbol or Markings	Description
	Conforms to relevant Australian EMC requirements.
	Manufacturer.
	Reference number.
	Serial Number.
	Safety Class II equipment (reinforced insulation).
	This mark shows the pin out polarity on the AC/DC Power Adapter.
	Enclosure ingress protection code per IEC 60529.
	China Compulsory Certificate.
	The most recognized International Safety mark. This safety listing signifies that the product was tested to IEC60601–1.
	Recycling in China.
	China RoHS compliance.
	RoHS directive compliance.
	The new DOE Level VI efficiency standard mandates that No-Load power consumption does not exceed 0.100 W for EPS ranging from <1 W to ≤ 49 W and does not exceed 0.210W for EPS >49W to ≤250W.
	The CB Scheme is an international program created by the International Electrotechnical Commission for Electrical Equipment (IECEE) for the acceptance of product safety test results among participating laboratories and certification organizations around the world.
	Warning.

1.2.1 Product Label

The product label for the TD Pilot is located under the Adjustable Stand on the bottom of the device, see *Illustration 1: Location of Product Label*, page 9.

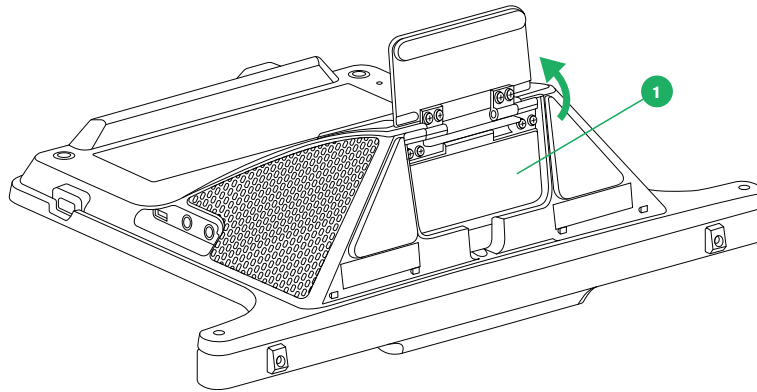

Illustration 1: Location of Product Label

Position	Description
1	Product Label

Rotate the Adjustable Stand to access the product label.

1.3 Intended Use

The TD Pilot is intended primarily as a speech generating device. The TD Pilot is intended to provide, and act as, a compliment for everyday communication for people who have challenges in their ability to speak due to injury, disability or illness. This intended use is reflected in design features such as long-lasting batteries, superior sound quality, high durability and alternative input methods including Tobii Eye tracking.



Contraindication: The TD Pilot device should never be, for the user, the only means of communicating important information.

In case of failure of the TD Pilot device, the user cannot communicate using it.

1.4 Package Contents



It is recommended to keep the original packaging materials for the TD Pilot.

If the device needs to be returned to Tobii Dynavox for warranty-related issues or repair, it is beneficial that the original packaging or equivalent is used for shipping. Most shipping carriers require at least 2 inches of packing material around the device.

Note: Due to Joint Commission regulations, any shipping materials (including boxes) sent to Tobii Dynavox must be discarded.

1.4.1 TD Pilot

The items below are included with your TD Pilot package:

- TD Pilot
 - 1 Apple iPad
 - 1 TD Pilot Base with built-in Tobii IS5TDL Eye Tracker. (Market dependent)
 - 1 TD Pilot Case for Apple iPad Pro 5th generation (Market dependent)
 - Connection Cable USB-C to USB-C
 - Pre-Installed Battery
 - Pre-installed ConnectIT/Rehadapt mount plate
- Charger with cable
- Connection cable Lighting to USB C
- Phillips Screw driver
- Getting Started Guide
- Safety and compliance
- Adjustable Bracket

Outer box

- Software Training cards
- Warranty document
- iPad Box (without iPad)
- Carry Bag (Market dependent)

2 Safety

The TD Pilot device has been tested and approved as compliant to all the Specifications and Standards listed in *Appendix B Compliance Information, page 38* of this manual and in the *Appendix D Technical Specifications, page 41* -- including, but not limited to, the Medical Device Standard (Class 1/Type B). Nevertheless, in order to ensure safe operation of your TD Pilot device, there are a few safety warnings to bear in mind:



No modification of this equipment is allowed.



Repairs to a Tobii Dynavox device must only be performed by Tobii Dynavox or a Tobii Dynavox authorized and approved repair center.



Contraindication: The TD Pilot device should never be, for the user, the only means of communicating important information.

In case of failure of the TD Pilot device, the user cannot communicate using it.



The TD Pilot is not to be used as a life supporting device, and it shall not be relied on in case of loss of function due to power loss or other causes.



There could be a choking hazard risk if small parts detach from the TD Pilot device.



The TD Pilot device shall not be exposed to or used in weather conditions outside the Technical Specification of the TD Pilot device.



The TD Pilot device shall only be used with TD Pilot specific Accessories that have a mounting instruction included with the accessory.



The charging cable could present strangulation hazards to young children. Never leave small children unattended with the charging cable.



Young children or people with cognitive disabilities should not have access to, or the use of, the TD Pilot device without parental or guardian supervision.



In case the TD Pilot device malfunctions or an ESD event, restart the device.



Do not attach any decorations, stickers, papers, or similar on the screen side of the TD Pilot device. These may interfere with the Eye tracking or touch screen performance.



Never force a connector into a port. If the connector and port do not join with reasonable ease, they probably do not match. Make sure that the connector matches the port and that you have positioned the connector correctly in relation to the port.

2.1 Avoiding Hearing Damage

 Permanent hearing loss may occur if earphones, headphones or speakers are used at high volume. To prevent this, the volume should be set to a safe level. You can become desensitized over time to high sound levels which may then sound acceptable yet still could be damaging your hearing. If you experience symptoms such as ringing in your ears, please lower the volume or stop using the earphones/headphones. The louder the volume, the less time is required before your hearing could be affected.

Hearing experts suggest the following measures to protect your hearing:

- Limit the amount of time you use earphones or headphones at high volume.
- Avoid turning up the volume to block out noisy surroundings.
- Turn the volume down if you cannot hear people speaking near you.

To establish a safe volume level:

- Set your volume control at a low setting.
- Slowly increase the sound until you can hear it comfortably and clearly, without distortion.

 The TD Pilot device can produce sounds in decibel ranges that may cause hearing loss for a normal hearing person, even when exposed for less than a minute. The maximum sound level of the unit is in parity with the sound levels that a healthy young person can produce while screaming. Since the TD Pilot device is intended as a voice prosthetic, it shares the same possibilities and potential risks of causing harm to hearing. The higher decibel ranges are offered to enable communication in a noisy environment and should be used with care and only in said noisy environments.

2.2 Power Supply and Batteries

 The TD Pilot device uses lithium-ion batteries. These batteries have a storage temperature range of between -20 °C/-4 °F and 40 °C/104 °F within 3 months.

If you are in a hot environment, be aware that it can affect the ability to charge the batteries. The internal temperature has to be between 0 °C/32 °F and 45 °C/113 °F for the batteries to charge. If the internal battery temperature raises above 45 °C/113 °F the batteries will not charge at all.

Move the TD Pilot device and the batteries to a cooler environment to let the batteries charge properly.

 Avoid exposing the batteries to fire or to temperatures above 50 °C/122 °F. These conditions may cause a battery to malfunction, generate heat, ignite or explode. Be aware that it is possible, in a worst case scenario, for temperatures to reach greater than those stated above in, for example, the trunk of a car on a hot day. So, storing the device, with batteries installed, in a hot car trunk could conceivably lead to a malfunction.

 Do not disassemble or harm the battery. Follow the environmental laws and regulations which apply in your area when disposing of batteries.

 The battery may only be replaced by the user with a TDBW1 battery pack sold by Tobii Dynavox. There is a risk of explosion if the battery is replaced with an incorrect type.

 For safe operation of the TD Pilot device, use only chargers, batteries, and accessories approved by Tobii Dynavox.

 Do not open (except for the battery cover), or modify, the casing of the TD Pilot device or of the power supply, since you may be exposed to potentially hazardous electrical voltage. The device contains no user serviceable parts. If the TD Pilot device or its accessories are mechanically damaged, **do not to use them**.

 If the battery is not charged and the TD Pilot is not powered up by the power supply, the TD Pilot device will shut down.

 If the Power Supply Cord becomes damaged, contact Tobii Dynavox for replacement.

 Do not connect any devices with a non-medical grade power supply to any connector on the TD Pilot device. Furthermore, all configurations shall comply with the system standard IEC 60601-1-1. Anyone who connects additional equipment to the signal input part or signal output part is configuring a medical system and is therefore responsible for ensuring that the system complies with the requirements of the system standard IEC 60601-1-1. The unit is for exclusive interconnection with IEC 60601-1 certified equipment in the patient environment and IEC 60XXX certified equipment out-side of the patient environment. If in doubt, consult the technical services department or your local representative.

 The appliance coupler of the power supply or separable plug is used as the Mains Disconnection Device, please do not position the TD Pilot device so that it is difficult to operate the disconnection device.

 Special regulations apply to shipping Lithium-ion batteries. If dropped, crushed, or short-circuited, these batteries can release dangerous amounts of heat and may ignite, and are dangerous in fires.

Please reference IATA regulations when shipping lithium metal or lithium-ion batteries or cells: <http://www.iata.org/whatwedo/cargo/dgr/Pages/lithium-batteries.aspx>

 Do not leaving batteries uncharged for long periods of time to avoid deep discharge issues.

2.3 Mounting

 The TD Pilot should be mounted according to the instructions of the approved mounts used. Tobii Dynavox or its agents are not liable for damage or injuries to a person or its property due to a TD Pilot falling from a mounted configuration. The mounting of a TD Pilot is done entirely at the user's own risk.

2.4 Emergency

Do not rely on the device for emergency calls or banking transactions. We recommend having multiple ways to communicate in emergency situations. Banking transactions should only be carried out with a system recommended by, and approved according to the standards of your bank.

2.5 Infrared

 The TD Pilot emits pulsed infrared (IR) light from the eye tracker. Other devices controlled by IR or susceptible to disturbance by IR light might be affected by the IR light emitted from the TD Pilot. Do not use the TD Pilot in the vicinity of such devices if their functionality is of critical importance.

2.6 Epilepsy

 Some people with **Photosensitive Epilepsy** are susceptible to epileptic seizures or loss of consciousness when exposed to certain flashing lights or light patterns in everyday life. This may happen even if the person has no medical history of epilepsy or has never had any epileptic seizures.

A person with Photosensitive Epilepsy would also be likely to have problems with TV screens, some arcade games, and flickering fluorescent bulbs. Such people may have a seizure while watching certain images or patterns on a monitor, or even when exposed to the light sources of an eye tracker. It is estimated that about 3-5% of people with epilepsy have this type of Photosensitive Epilepsy. Many people with Photosensitive Epilepsy experience an "aura" or feel odd sensations before the seizure occurs. If you feel odd during use, move your eyes away from the eye tracker.

2.7 Electricity

 Do not open the casing, except for the battery cover, of the TD Pilot device, since you may be exposed to potentially hazardous electrical voltage. The device contains no user serviceable parts.

2.8 Software



Software other than that which is pre-installed on the TD Pilot is installed at the user's own risk. External software could cause the TD Pilot to malfunction and might not be covered by the warranty.

2.9 Child Safety



The TD Pilot is an advanced computer system and electronic device. As such it is composed of numerous separate, assembled parts. In the hands of a child these parts have the possibility of being separated from the device, possibly constituting a choking hazard or another danger to the child.

Young children should not have access to, or the use of, the device without parental or guardian supervision.

2.10 Eye Tracking

Some people may experience a certain amount of fatigue (due to intentional eye focusing and hard concentration) or even a dryness of the eyes (due to less frequent blinking) when first getting used to Eye tracking. If you are experiencing fatigue or dry eyes start off slowly and limit the length of your Eye tracking sessions to your comfort level. Remoisturizing eye drops can be helpful to combat dryness.

2.11 Third Party



Tobii Dynavox assumes no responsibility for any consequence resulting from use of the TD Pilot in a manner inconsistent with its intended use, including any use of the TD Pilot with third-party software and/or hardware that changes the intended use.

3 Overview of the TD Pilot

3.1 Key Features

The TD Pilot has some built-in features.

Standard features: 1 × Eye tracker (Market dependent), 2 × speakers, 2 × switch ports, 1 × microphone, 1 × head phone jack, 2 × buttons and 1 × USB-C port.

3.2 Product Layout

3.2.1 Ports, Sensors and Device Buttons

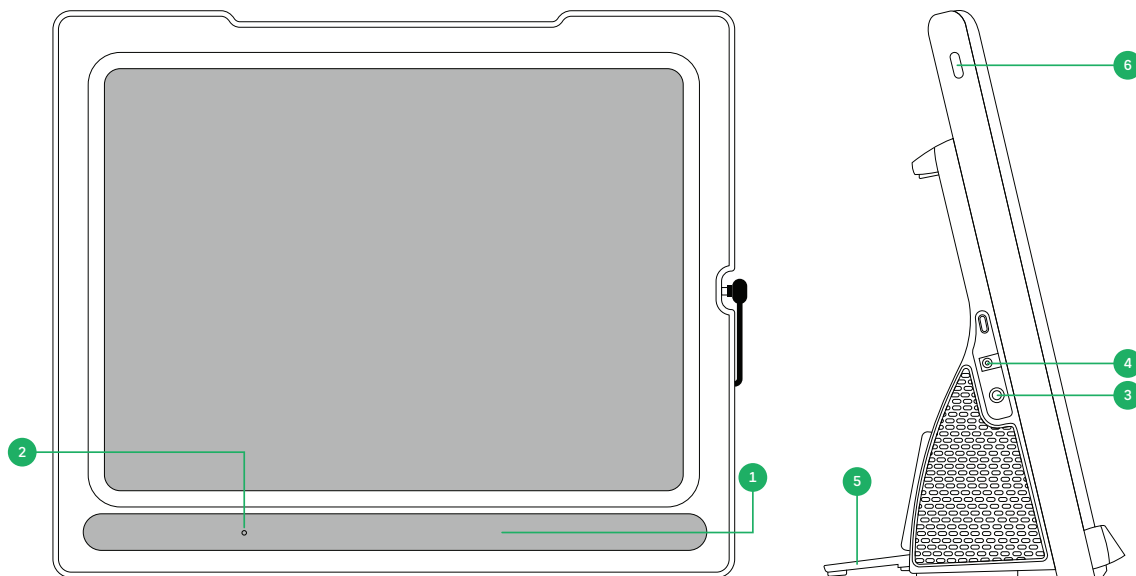

Illustration 2: Front and Right Side

Position	Description	Position	Description
1	Built-in Tobii IS5TDL Eye Tracker	4	Power Connector
2	Microphone	5	Folding Leg
3	Head phone jack 3.5 mm	6	Power Button on iPadOS Device

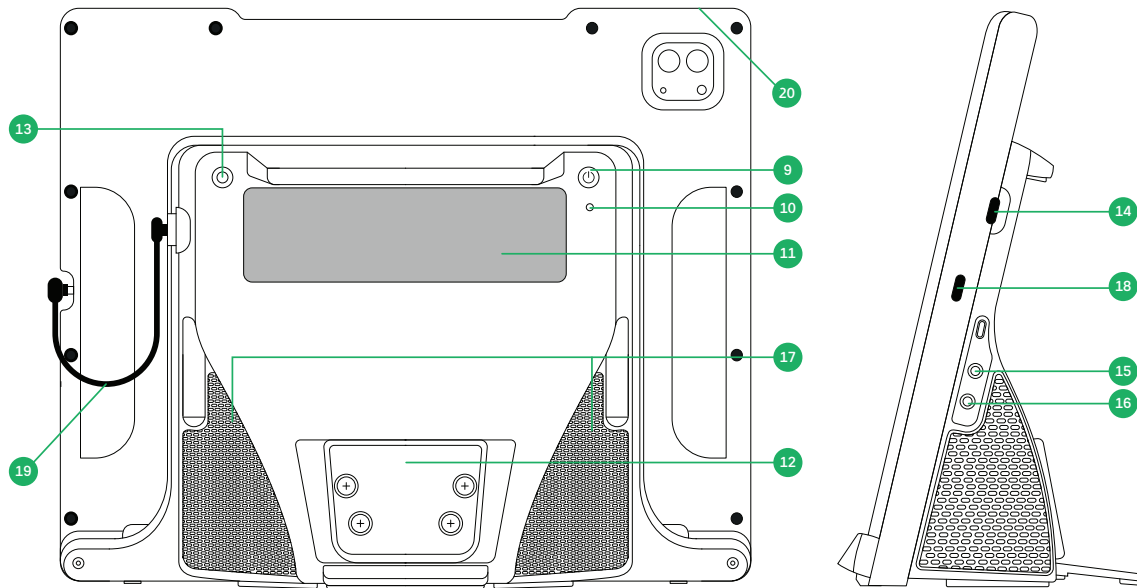

Illustration 3: Back and Left Side

Position	Description	Position	Description
9	Power Button	15	Switch Port 1
10	Status LED	16	Switch Port 2
11	Partner Window	17	Speakers
12	Mounting Plate	18	iPad charging port
13	Track Status Button	19	USB-C — USB-C Cable
14	USB-C Connector	20	Volume Buttons on iPadOS Device

! Never force a connector into a port. If the connector and port do not join with reasonable ease, they probably do not match. Make sure that the connector matches the port and that you have positioned the connector correctly in relation to the port.

4 Batteries in the TD Pilot

4.1 Batteries

The TD Pilot device has two built-in batteries. One battery in the iPadOS device and one in the TD Pilot Base.

To check the battery status of the iPad in the TD Pilot

- In TD Talk the battery status will be shown in the top right corner of the screen.
- In TD Snap the battery status is displayed on the Dashboard.
- In TD CoPilot, see *6.3.2 Battery*, page 30

To check the battery status of the TD Pilot Base in the TD Pilot:

- Momentarily press the power button while the unit is on.
- In TD CoPilot, see *6.3.2 Battery*, page 30

An indication of battery level will appear on the Partner Window for a couple of seconds showing the battery status of the TD Pilot Base. There is no battery indicator (e.g. LED) that sends out a warning when the battery is low. Power is shared between the iPadOS device battery and the TD Pilot battery so that, under continuous use, they will reach 0% at about the same time. iPadOS will produce its own warning on the iPadOS device screen at 10% and 5% remaining. Normally this means that the TD Pilot battery is running low too. For more information, see *Appendix D Technical Specifications*, page 41.

4.2 Charging the TD Pilot

1. Connect the Power cable to the Power Connector on the TD Pilot device.
2. Connect the Power adapter to an electrical outlet and charge the TD Pilot device until the battery is fully charged.

For device storage and battery charging temperatures, see *2 Safety*, page 11.

4.2.1 The Status LED Behavior

The status LED will shine with three (3) different colors:

- Fault — Red
- Charging — Blue
- Power On — Pulsing green



For example, when the unit is charging, the LED will be blue, regardless of whether the TD Pilot is powered On or not. If there is a fault, the LED will be red, regardless of any other conditions.

For more information, see *Appendix C Status LED Information*, page 40

4.3 Changing the Battery



The battery may only be replaced by the user with a TDBW1 battery pack sold by Tobii Dynavox. There is a risk of explosion if the battery is replaced with an incorrect type.

To change the battery, follow the instructions included in the replacement battery pack.

5 Using the TD Pilot

No skill other than reading and using one's hands for many steps is necessary for setting up the TD Pilot device. Follow this User's Manual and the Getting Start Guide.

5.1 Starting the TD Pilot

Start the devices the following way:

1. Press the power button on the iPadOS Device. (Position 6 in *Illustration 2: Front and Right Side, page 15*)
2. Press the power button near the the top of the TD Pilot Base device. (Position 9 in *Illustration 3: Back and Left Side, page 16*)

When you have started the device, the Power LED will shine in Red, pulse Blue or Green.

For example, solid blue indicates that it is charging but NOT powered on. If the LED is PULSING (any color) the TD Pilot is ON. Otherwise it is OFF.

For more information about the LED Behavior, see *4.2.1 The Status LED Behavior, page 17*.

5.2 Shutting Down the TD Pilot

The iPadOS device and TD Pilot Base shut down independently. The TD Pilot Base can only be shut down using the power button.

Usually the iPadOS device never needs to be shut down, just like a mobile phone. When the screen is locked the iPadOS device battery lasts for days without charging.

To power off the TD Pilot Base, push and hold the power button (Position 9 in *Illustration 3: Back and Left Side, page 16*) for 3 seconds. If, for some reason, the accessory crashes or is unresponsive hold the power button for 10 seconds will force a shutoff.

5.3 First Start Up



When you start your TD Pilot for the first time, you are required to go through the Apple out of the box experience. At the end of setup the TD Pilot. specific apps will be installed on the Apple iPadOS device. The entire set up process takes between 10-15 minutes.



5.4 Setting Up Eye Gaze Access



If Applicable

5.4.1 Configuring the iPadOS for Gaze Access

Step	Location	Action
1		 (in iPadOS).
2	On the left side	Select Face ID & Passcode .  Not available on funded/managed devices.
3	On the right side	Toggle USB Accessories ON, under ALLOW ACCESS WHEN LOCKED.  Not available on funded/managed devices.

- 4 On the left side Select **Home Screen & Dock**.
 - 5 On the right side Select **Use Large App Icons**, under APP ICONS.
 - 6 On the left side Select **Display & Brightness**.
 - 7 On the right side Select **Dark**, under APPEARANCE.
 - 8 Select **Text Size**.
 - 9 Move the Text Size slider all the way to the right.
-  This increases the text size in all compatible applications.
- 10 On the left side Select **Display & Brightness**.
 - 11 On the right side Select **View**.
-  This setting is not available on iPads smaller than 11 inches.
- 12 Select **Zoomed**.
 - 13 Select **Set**.
 - 14 Select **Use Zoomed**, in the popup.
 - 15 On the left side Select **General**.
 - 16 Select **Shut Down**
 - 17 Press the power button on the iPadOS Device to restart the device. (Position 6 in *Illustration 2: Front and Right Side*, page 15).

5.4.2 Setting up AssistiveTouch

AssistiveTouch is designed for people who have difficulty touching the screen. The AssistiveTouch menu allows you to do "touch" functions, such as tap and scroll, using eye gaze. It also provides gaze-accessible shortcuts to things like the Home screen and App Switcher, typically accessed through gestures. AssistiveTouch is used for access via eye gaze in all iOS apps, except TD communication apps, including TD Talk and TD Snap.

 AssistiveTouch is not intended to be used for TD Talk and TD Snap. The TD Talk and TD Snap apps allow for eye gaze input without AssistiveTouch enabled.

Step	Location	Action
------	----------	--------

- | | | |
|---|-------------------|--|
| 1 | |  (in iPadOS).
Select Settings |
| 2 | On the left side | Select Accessibility . |
| 3 | On the right side | Select Touch , under PHYSICAL AND MOTOR. |
| 4 | | Select AssistiveTouch |
| 5 | | Toggle AssistiveTouch ON. |

 Eye Gaze is now enabled

You will see the Pointer, which shows the location of your eye gaze. The AssistiveTouch menu button appears on the right side of the screen.

 If you are prompted to customize the Top Level Menu, select **Cancel**.

- | | | |
|---|--|---|
| 6 | | Drag the AssistiveTouch menu button to the top third of the screen on the right side. |
|---|--|---|

5.4.3 Customizing the AssistiveTouch Menu

Step	Location	Action
------	----------	--------

- 1 Select **Settings**  (in iPadOS).
- 2 On the left side Select **Accessibility**.
- 3 On the right side Select **Touch**, under PHYSICAL AND MOTOR.
- 4 Select **AssistiveTouch**.
- 5 Select the **Customize Top Level Menu**.
- 6 Select **+** to change the number of icons to 8.
- 7 Select **Notification Center**.
- 8 Swipe to the bottom of the list.
- 9 Select **Toggle Pause/Resume Dwell**.
- 10 Tap anywhere outside the list to close it.
- 11 Select the **Gestures** button.
- 12 Swipe to **Move Menu**.
- 13 Select **Move Menu**.
- 14 Tap anywhere outside the list to close it.
- 15 Continue editing the menu icons until your menu matches this:

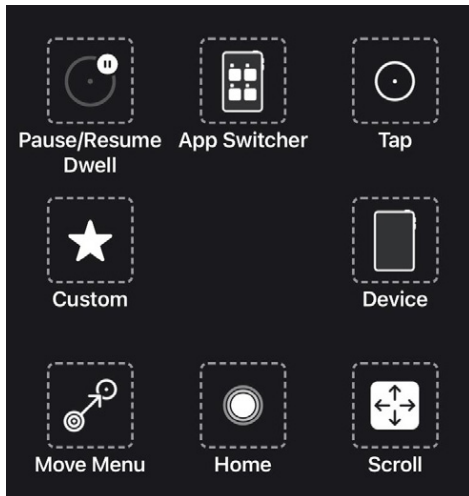

AssistiveTouch Menu for TD Talk

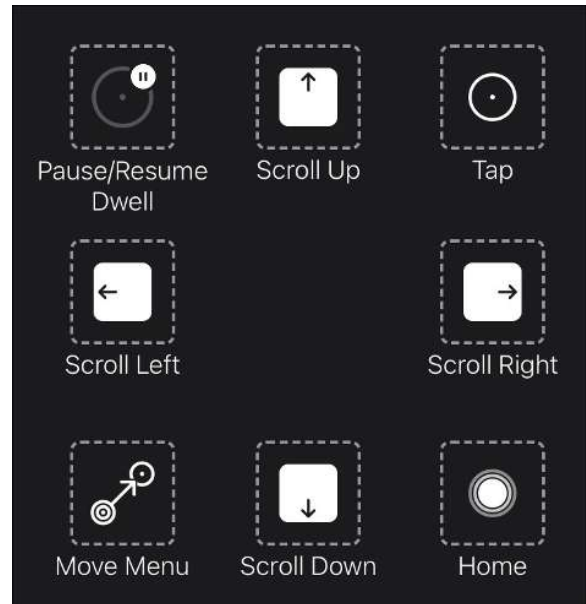

AssistiveTouch Menu for TD Snap

5.4.4 Configuring Dwell Control

- | Step | Location | Action |
|------|---|-------------------------------|
| 1 | Select Settings  (in iPadOS). | |
| 2 | On the left side | Select Accessibility . |

- 3 On the right side Select **Touch**, under PHYSICAL AND MOTOR.
 - 4 Select **AssistiveTouch**.
 - 5 Swipe to the **Dwell Control**
 - 6 Toggle **Dwell Control** ON.
 - 7 Swipe to the bottom.
 - 8 Select the – (minus sign) next to **Seconds** to change the dwell time to 1.5 seconds.
-  This dwell time setting is to get you started. You can change the dwell time again later to suit your needs.
- 9 Swipe up from the center bottom of the screen to go to the **Home Screen**.

5.4.5 Waking and Unlocking Your iPad

Your iPad wakes automatically when the eye tracker detects your eyes. Unlock the iPad by selecting the AssistiveTouch Button, then Home.

Try it now:

1. Press the power button on the iPad device (Position 6 in *Illustration 2: Front and Right Side, page 15*) to lock the iPad.
2. Look at the screen for a few moments.
3. The iPad will wake and display the lock screen.
4. Tap or use your eyes to select the **AssistiveTouch menu button**.
5. Select **Home**.



If you are interested in extra security on your device, we recommend using Face ID. Face ID allows you to unlock your device without entering a passcode each time.

Set up Face ID in iPadOS Settings > Face ID & Passcode.

5.5 Using Apps with AssistiveTouch (if Applicable)

When you are ready to venture outside of your communication software, you'll use AssistiveTouch to access the other apps on your iPad. The AssistiveTouch eye gaze settings and behaviors are different from the ones in your communication software, so you may need to make adjustments in the iPad OS Settings.

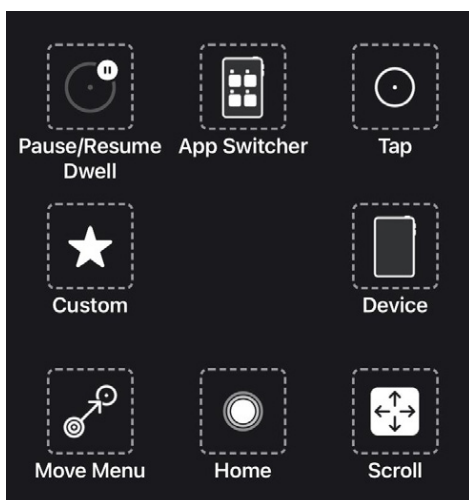

AssistiveTouch Menu for TD Talk

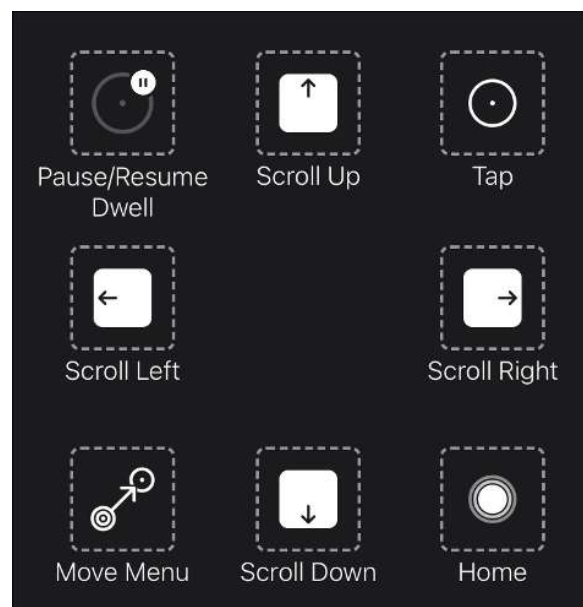

AssistiveTouch Menu for TD Snap

The AssistiveTouch Menu is an Eye gaze-accessible navigation tools that enable you to tap, swipe, adjust the volume, switch between apps, and more using your eyes.

 Be sure to look at the Refining Eye Gaze cards if you are having any challenges using AssistiveTouch.

5.5.1 Accessing the AssistiveTouch Menu

TD Talk

1. Fixate your gaze below the screen, in the middle of the eye tracker or the area of the eye tracker.

The  (AssistiveTouch) button will become visible in the lower middle part of the screen.

2. Select the  (AssistiveTouch) button to activate AssistiveTouch.

The  (AssistiveTouch) button will become visible on the screen.

3. Select the  (AssistiveTouch) button to open the AssistiveTouch Menu.

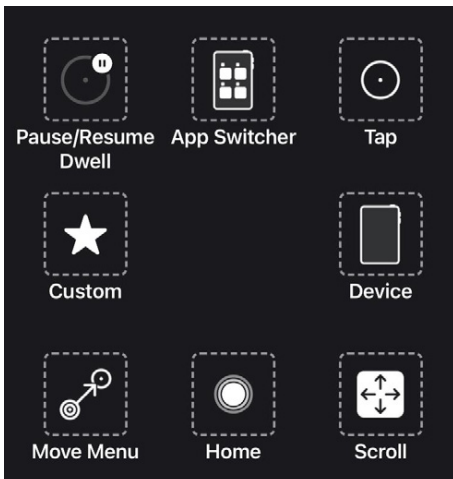

TD Snap

1. Select the **Dashboard** button in the Toolbar.
2. Select the **Eye Gaze (iOS)** button.
3. Select the **Start AssistiveTouch** button.

The  (AssistiveTouch) button will become visible on the screen.

4. Select the  (AssistiveTouch) button to open the AssistiveTouch Menu.

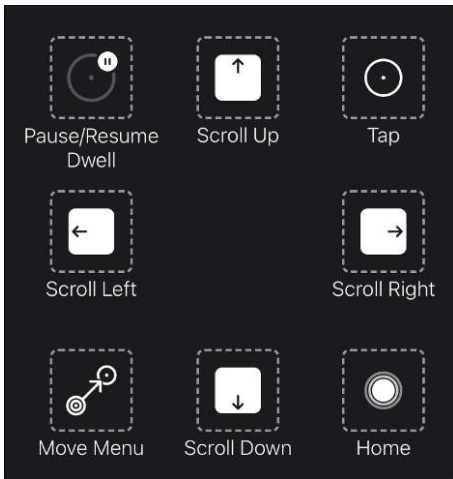

5.5.2 Taking a Break When Needed

Pause the eye tracking to read or rest, then resume eye gaze when you wish.

1. Access the AssistiveTouch menu.
For more information, see *5.5.1 Accessing the AssistiveTouch Menu, page 22*
2. Select the **Pause Dwell** to pause the eye tracking.

 Repeat the steps to resume eye tracking.

5.5.3 Using the iPad with your Eyes

Tap and Scroll are available in the AssistiveTouch Menu on the top level. Other touch gestures such as Hold and Drag, Long Press, and Double Tap are found under Custom in the AssistiveTouch Menu.

To scroll

1. Access the AssistiveTouch menu.
For more information, see *5.5.1 Accessing the AssistiveTouch Menu, page 22*
2. Depending on the communication software:

For TD Talk:	For TD Snap:
<ol style="list-style-type: none"> 1. Select the Scroll button from the AssistiveTouch Menu 2. Select the scroll direction. 3. Position your Pointer in the area of the screen where you want to scroll. 	<ol style="list-style-type: none"> 1. Select the scroll direction from the AssistiveTouch Menu. 2. Position your Pointer in the area of the screen where you want to scroll.

AssistiveTouch falls back to Tap after you perform a different action like pause or scroll. You can change the action it falls back to or remove it altogether in: **iPad OS Settings > Accessibility > Touch > AssistiveTouch > Fallback Action**.

5.5.4 Moving the AssistiveTouch Button

You may need to move the AssistiveTouch Button around the screen to get it out of your way.

1. Access the AssistiveTouch menu.
For more information, see *5.5.1 Accessing the AssistiveTouch Menu, page 22*
2. Select **Move Menu** in the AssistiveTouch Menu
3. Hold your gaze on the screen where you would like the AssistiveTouch Menu Button to be.

5.5.5 Choosing Appropriate Apps

Ask yourself these questions when considering apps for use with eye gaze.

- Do you have the skills (e.g., Tap, Scroll, Long Press) needed to use the app?
- If you do not have the required skills, is the app a good way for you to practice and build skills?
- Is the app of high interest? When you are motivated, you are more likely to work harder and persevere when trying to access difficult apps.
- Are there settings in iPad OS or TD CoPilot that can help make the app more accessible with eye gaze? For more information, see *A4.4 Refining Eye Gaze, page 36*.
- Can you configure settings within the app to accommodate your current abilities? This might include changing from portrait to landscape, modifying response time or time out settings in games, replacing complex tasks (select and drag) with more simple ones (select), or displaying fewer choices on the screen.

5.6 Using Eye tracking

If Applicable

The TD Pilot devices operate with precision regardless of glasses, contact lenses, eye color or light conditions. Eye tracking enables you to control the iPad with your eyes using AssistiveTouch applications. AssistiveTouch allows you to interact with applications and can help hone in the eye tracking experience through a variety of settings

5.6.1 Positioning

Prepare the user to start using eye tracking by positioning them comfortably. If they use glasses, make sure that they are wearing them and that the lenses are clean.

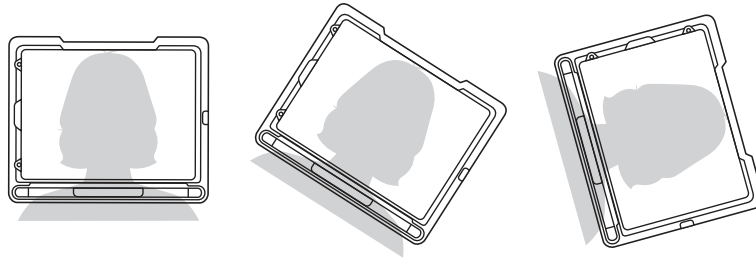

Place the TD Pilot on your mounting system or a stable surface in front of the user at, or slightly below, their eye level at a distance of about 65 cm (25.6 inches).

If their head is tilted left or right, tilt the TD Pilot to match. It is important that the angle of the screen surface match the angle of the user's face.

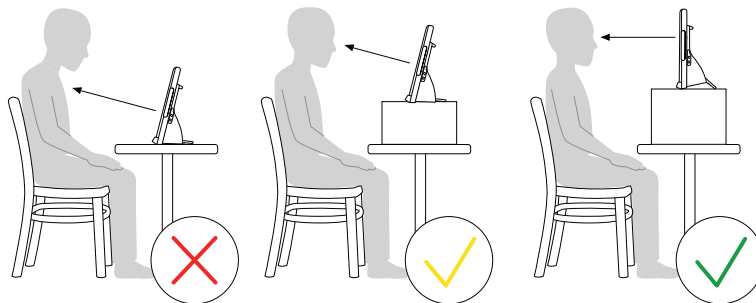

Most users, when seated at a table or desk, will need to have the TD Pilot positioned higher than the table surface.

You may need to refine the position of the device during the Calibrate steps, see *6.1 Calibration, page 28*.



Always adjust the position of the device to suit the user, not the other way around.

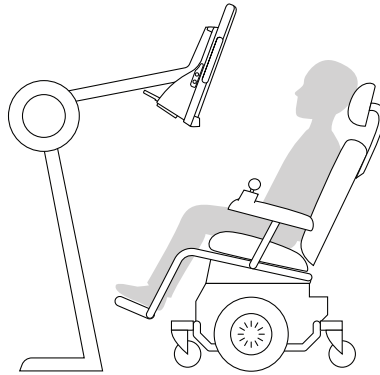

A mounting system is the best option for precise device positioning that is easy to adjust throughout the day. Several mounting options are available, including floor mounts, desk mounts, and wheelchair mounts. Visit www.TobiiDynavox.com or contact your local Tobii Dynavox partner.

5.6.2 Tips for Outdoor Usage

Here are some tips for better performance when using the eye tracker outside, especially in bright sunlight

- It may be beneficial to recalibrate at different points in the day due to environmental changes such as changing light or moving from indoors to outside.
- Use a baseball cap or similar to cast a shade on the eyes. This will significantly enhance the performance of the eye tracker.
- Avoid getting direct sunlight on the eye tracker for best eye tracking performance.



Positioning the TD Pilot in direct sunlight on a hot day may cause it to overheat.

5.6.3 Track Box

The TD Pilot allows for extensive freedom of head movement. Once the TD Pilot is properly calibrated and placed in front of the user, no further adjustments are required.

The TD Pilot produces an industry leading sized track box with the approximate dimensions of 30 cm × 20 cm × 20 cm / 11.8 in × 7.9 in × 7.9 in (Width × Height × Depth). The Track Box is an invisible box positioned approximately 60 cm (23.5 in) straight out from a point just above the middle of the screen.

At 70 cm (27.5 in) the TD Pilot allows for lateral Freedom of Head Movement in an area of about 50 × 36 cm (20 × 14 in) or 35 × 30 cm (13,8 × 11,8 in) depending on which Eye tracker the TD Pilot is equipped with. For more information, see *Appendix D Technical Specifications, page 41*.

In order to function properly for Eye tracking, the user needs at least one eye in the track box at all times.

5.6.4 Track Status

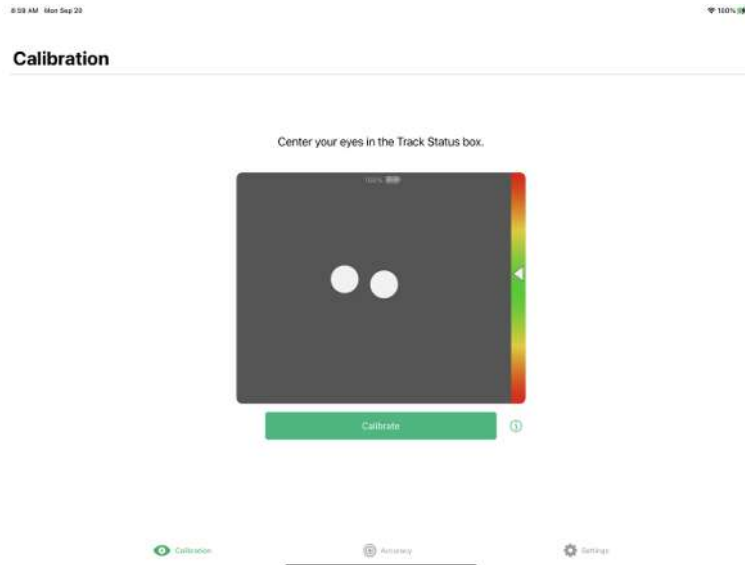

The **Track Status** function is used to check if the user is correctly positioned in front of the eye tracker.

- The Eye Indicators, the two (2) white dots — represents the user's eyes and how they are positioned towards the screen. For optimal position, the eye indicators should be in the middle of the black area.
 - The colorful bar on the right with the white arrow — How far or close the user is positioned from the screen.
 - If the white arrow is in the middle of the green area of the bar, the user is at the optimal distance from the screen.
 - If the arrow is on the lower part of the bar — move the user closer.
 - If the arrow is on the upper part of the bar — move the user farther away from the device.
1. Select one of the following ways to access the Track Status:
 - Select the **Track Status** button, position 13 in *Illustration 3: Back and Left Side, page 16*, on the device.



- Open the TD CoPilot app by selecting the TD CoPilot icon.
2. Position the user.

5.7 Using the Adjustable Stand

The TD Pilot comes with a built-in Adjustable Stand, which allows the user to place the TD Pilot device in more positions for the best possible Eye tracking.

To use the Adjustable Stand follow these instructions:

1. Fold out the Adjustable Stand from its position in the bottom of the device.

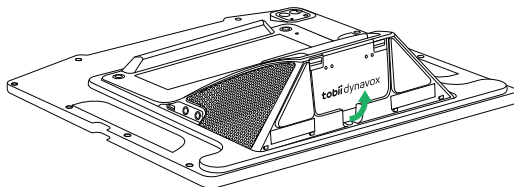

The Adjustable Stand is folded in underneath the bottom of the device.

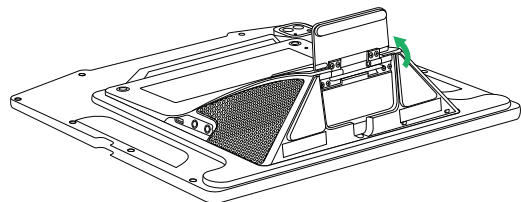

Rotate the Adjustable Stand out to preferred position.

2. Select in which position to use the Adjustable Stand.

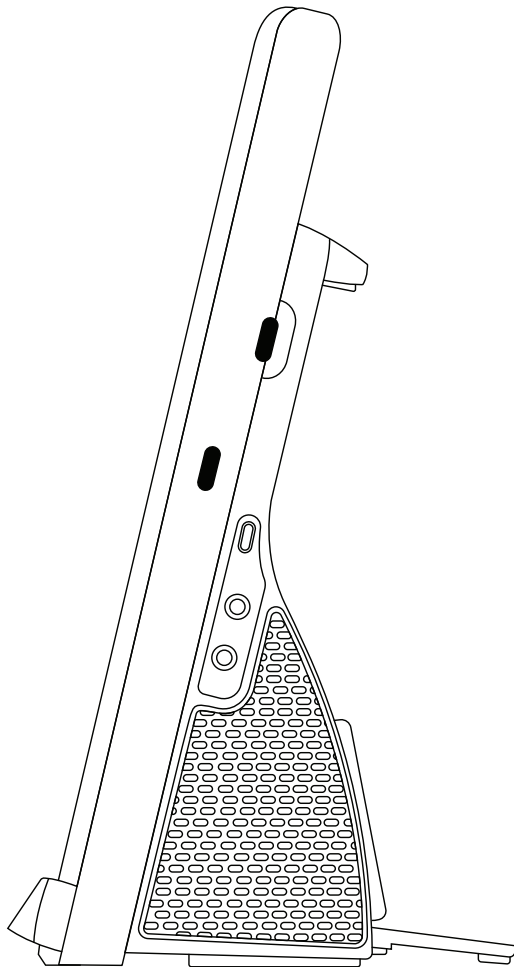

Place the TD Pilot in upright position.

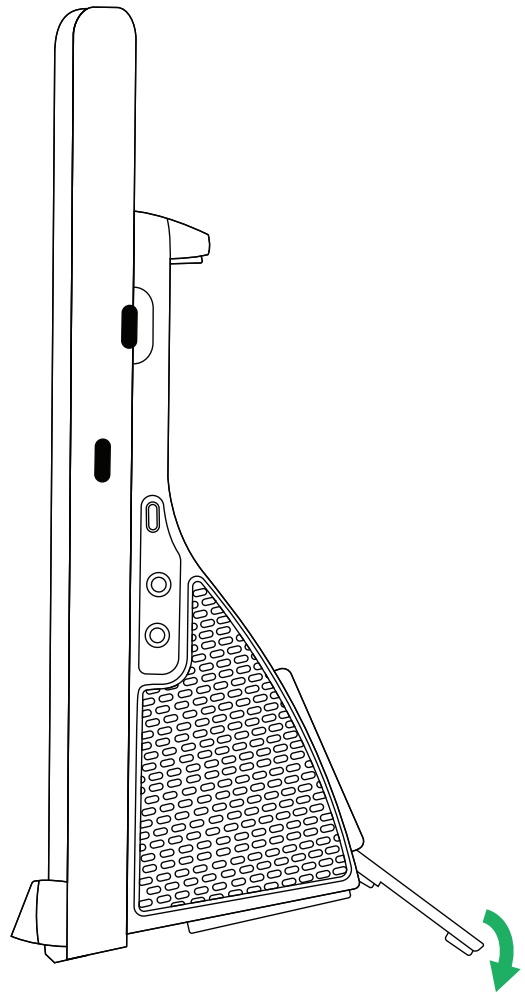

Adjust the angle of the Adjustable Stand to give the TD Pilot a good alignment with the user.

5.8 Using the Partner Window

The Partner Window will mirror the Message Window in TD Talk and TD Snap or TD Snap. For privacy, the user can toggle the Partner Window on/off from within TD Talk and TD Snap or TD Snap.

There are also other options for the Partner Windows that can be toggled on/off like options for Show text while speaking and adding ellipsis while typing.

5.9 Adjusting the Volume

To adjust the volume use the Volume Up button and Volume Down button on the on the iPadOS device.



Volume adjustments can also be done in your Tobii Dynavox communication software.



For TD Talk, the user must use the volume controls in the Control Center of the iPadOS.

6 TD CoPilot

The TD CoPilot software can be used to calibrate the eye tracker, define the settings for calibration, check the battery life of the TD Pilot Base etc.

To access the TD CoPilot follow this procedure:



1. Select the TD CoPilot app.
2. The TD CoPilot opens.

6.1 Calibration

The eye tracker in the TD Pilot can be calibrated here.

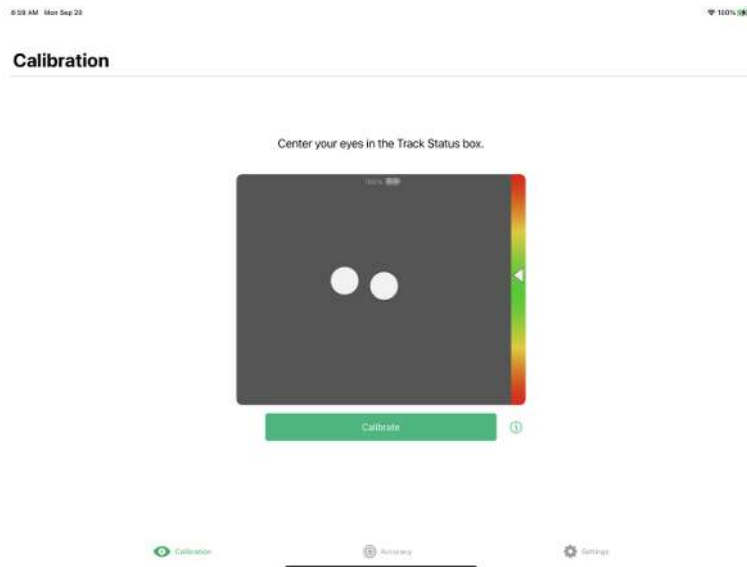

6.1.1 Start Calibration

1. Open the **TD CoPilot** app.
2. Make sure the user is correctly positioned in front of the TD Pilot device.
For more information about positioning, see [5.6.1 Positioning, page 24](#) and [5.6.4 Track Status, page 26](#).
3. Select the **Calibrate** button.
4. Follow the on-screen instructions.

6.2 Accuracy

On the Accuracy page the calibration can be tested, using pre-defined targets on the screen to see if the user needs to re-calibrate the Eye tracker.

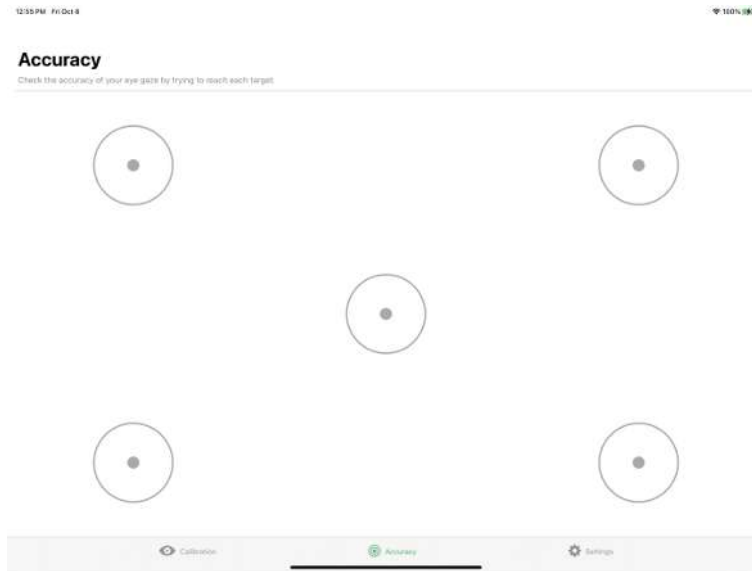

Look at each dot in each circle on the screen to see how accurate the eye tracking is in that area.

6.3 Settings

6.3.1 Calibration

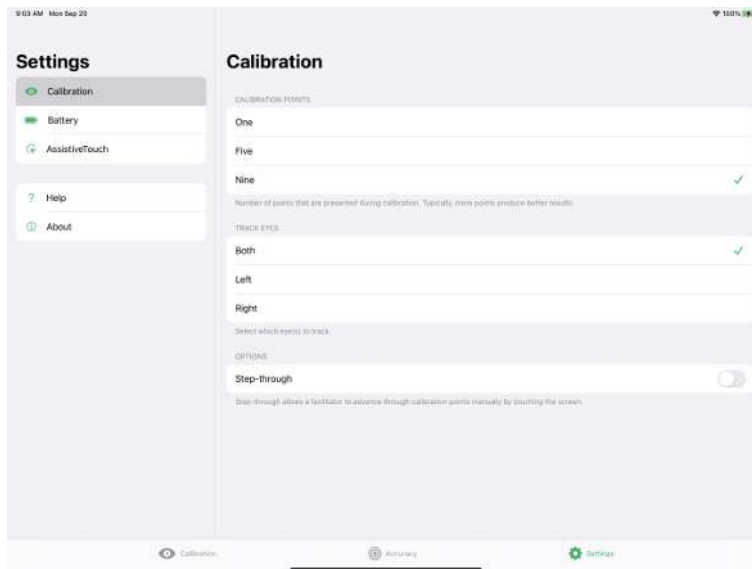

CALIBRATION POINTS

Select how many targets will be used to calibrate the eye tracker. The more calibration points used, the better calibration result will be:

1. Open the **TD CoPilot** app.
2. Select **Settings** button.
3. Select the **CALIBRATION POINTS**:
 - **One**
 - **Five**
 - **Nine (Default)**

TRACK EYES

Select which eye(s) the eye tracker should track when using Eye tracking:

1. Open the **TD CoPilot** app.
2. Select **Settings** button.
3. Select the **TRACK EYES - SELECT WHICH EYE(S) TO TRACK:**
 - **Both** — The eye tracker will track both of the eyes (will get the best performance) (**Default**)
 - **Left** — The eye tracker will only track the left eye.
 - **Right** — The eye tracker will only track the right eye.

OPTIONS

There are two options that can be activated:

1. Open the **TD CoPilot** app.
2. Select **Settings** button.
3. Select the **OPTIONS:**
 - **Step-Through** — Toggle **Step-Through** On to use step-through calibration function.

Step-through allows a facilitator to advance through calibration points manually by touching the screen. (**Default is Off**)

6.3.2 Battery

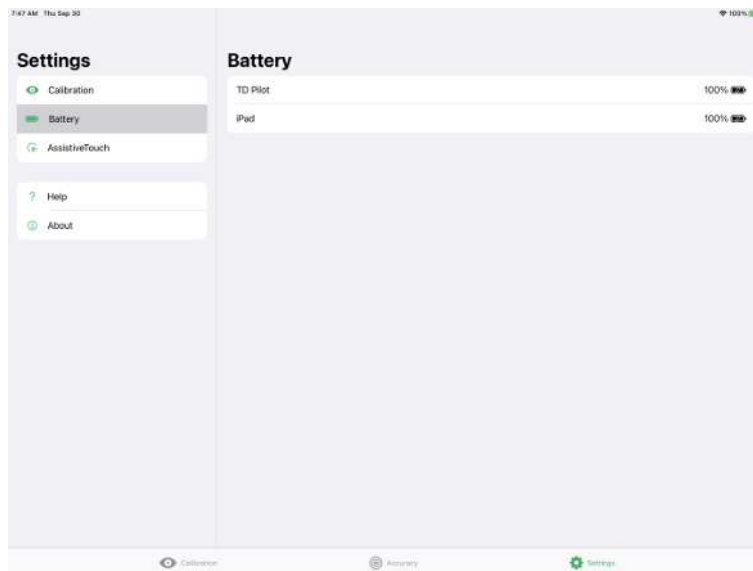

To see the status of the TD Pilot battery:

1. Open the **TD CoPilot** app.
2. Select **Settings**.
3. Select **Battery**



The iPad's battery may be seen at the top right of the iPad (or in a Widget) as well..

6.3.3 Assistive Touch

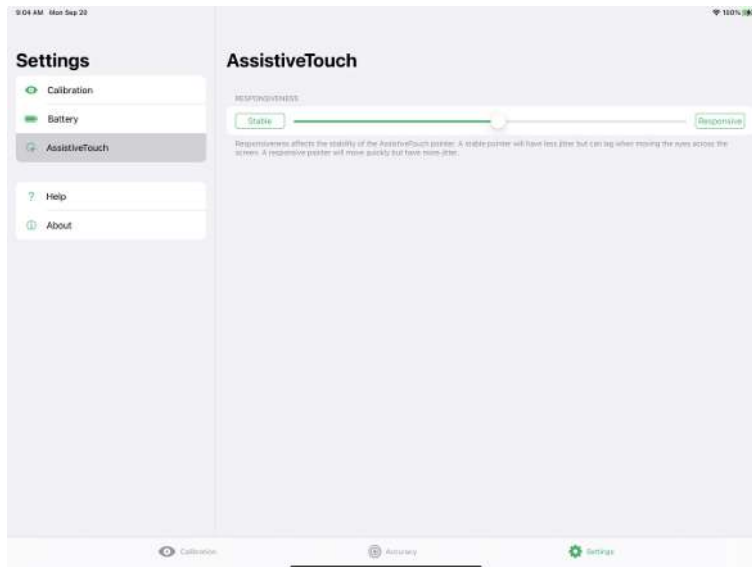

RESPONSIVENESS

Responsiveness affects the stability of the AssistiveTouch pointer. A stable pointer will have less jitter but can lag when moving the eyes across the screen. A responsive pointer will move quickly but have more jitter.

1. Open the **TD CoPilot** app.
2. Select **Settings**.
3. Select **Assistive Touch**
4. Select the **Stable** or **Responsive** buttons to set the **RESPONSIVENESS** level between **Stable** and **Responsive**.

6.3.4 Help

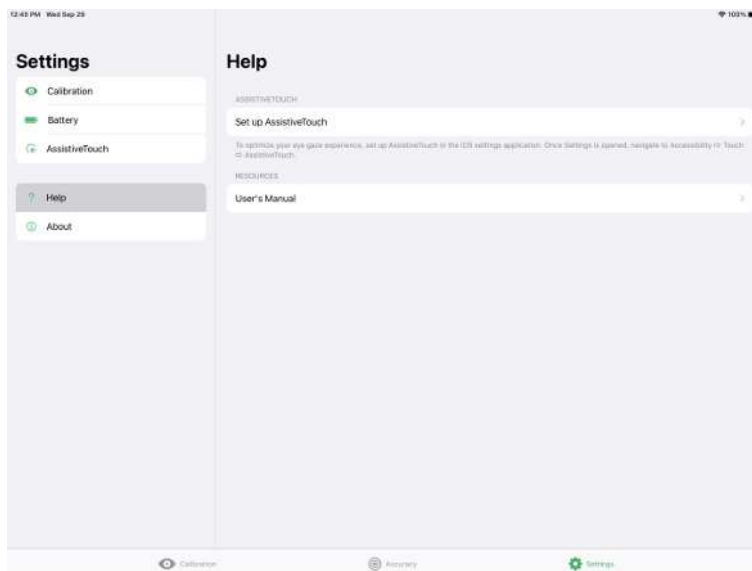

This page provides information about where to go to optimize the eye gaze experience and where to find the User's Manual.

ASSISTIVETOUCH

- Select the **Set up AssistiveTouch** button to go to the iPadOS settings.

RESOURCES

- Select the **User's Manual** button to open the User's Manual as a PDF on the iPadOS device.

6.3.5 About 

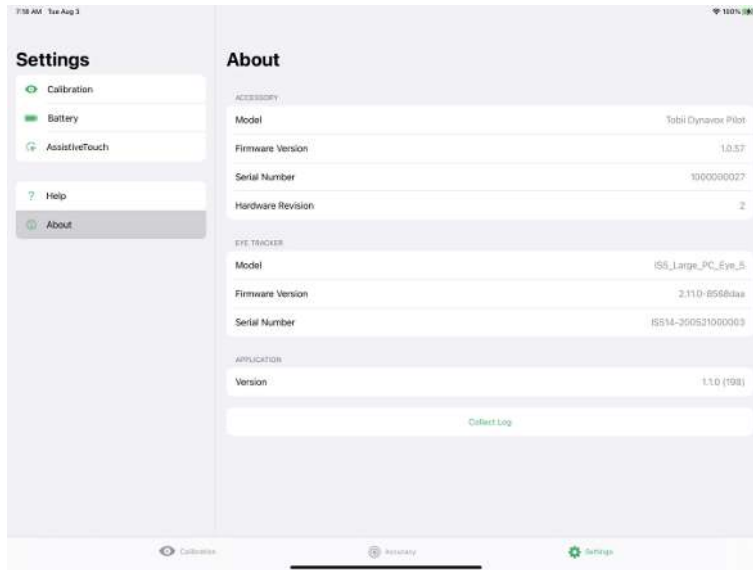

To get detailed information about the TD Pilot and eye tracker:

1. Open the **TD CoPilot** app.
2. Select **Settings**.
3. Select **About**.

To collect the logs for the TD Pilot and eye tracker:

1. Open the **TD CoPilot** app.
2. Select **Settings**.
3. Select **About**.
4. Select the **Collect Logs** button.

7 Product Care

7.1 Temperature & Humidity

7.1.1 General Use - Operating Temperature

The TD Pilot is best kept in dry conditions at room temperature. The recommended ranges for temperature and humidity for the device are as follows:

- Ambient temperature: 0°C to 35°C (32°F to 95°F)
- Humidity: 10% to 95% @40°C (104°F) (no condensation on the device)
- Atmospheric Pressure: 70 kPa to 106 kPa (525 mmHg to 795 mmHg)

7.1.2 Transportation and Storage

For transportation and storage the recommended range for temperature and the humidity value for the device is as follows:

- Temperature: -20°C to 45°C (-4°F to 113°F)
- Humidity: 10% to 95% @40°C (104°F)(no condensation on the device)
- Atmospheric Pressure: 70 kPa to 106 kPa (375 mmHg to 795 mmHg)

The TD Pilot is not waterproof or fully water resistant. The device should not be kept in excessively humid, damp or otherwise wet conditions. Do not submerge the device in water or in any other liquid. Be careful not to allow liquids to be spilled upon the device especially in the connector areas without the I/O covers in place.

The device is registered as IP Class 53.



The IP class pass for device only, with I/O covers in place. Adaptor mode is excluded.

7.2 Cleaning of the Device

1. Before cleaning, fully shut down your device.
2. Unplug your device.
3. Remove all cables.
4. Wipe over all external surfaces using 70 percent isopropyl alcohol wipe, 75 percent ethyl alcohol wipe, or Clorox Disinfecting Wipe for infection control.
5. Allow the device to dry naturally.
6. Any accessories included must also be disinfected in the same way.
7. If streaky residue remains from cleaning, buff screen with a soft dry cloth.
8. Dispose of used cleaning materials properly.



Do not use spray products directly on to the device as these may saturate the device and allow unwanted moisture into the unit.

7.3 Placement

Only use the recommended mounts specified by your local reseller or sales representative and make sure that they are mounted and fastened correctly according to the instructions. Do not place the device on unstable and uneven surfaces.

7.4 Transporting the TD Pilot Device

Disconnect all the cables from the TD Pilot while carrying the device.

When you transport the device for repair, shipment, or traveling, use the original casing and packaging materials and ensure that the TD Pilot device is powered down.



It is recommended to keep the original packaging materials for the TD Pilot.

If the device needs to be returned to Tobii Dynavox for warranty-related issues or repair, it is beneficial that the original packaging or equivalent is used for shipping. Most shipping carriers require at least 2 inches of packing material around the device.

Note: Due to Joint Commission regulations, any shipping materials (including boxes) sent to Tobii Dynavox must be discarded.

7.5 Disposing of Batteries

Do not dispose of the batteries in general household or office waste. Follow your local regulations for the disposal of batteries.

7.6 Disposing of the Device

Do not dispose of the TD Pilot device in general household or office waste. Follow your local regulations for the disposal of electrical and electronic equipment.

Appendix A Support, Warranty, Training Resources and Trouble-shooting

A1 Customer Support

For support, please contact your local representative or Support at Tobii Dynavox. In order to receive assistance as quickly as possible, make sure you have access to your TD Pilot device and, if possible, an internet connection. You should also be able to supply the serial number of the device, which you find under the Adjustable Stand on the TD Pilot Base.

For further product information and other support resources, please visit the Tobii Dynavox website www.tobiidynavox.com.

A2 Warranty

Please read the Manufacturer's Warranty paper included in the package.

 iPads purchased together with TD Pilot are not covered by this manufacturer's warranty

 Tobii Dynavox does not warrant that the Software on the TD Pilot will meet your requirements, that the operation of the software will be uninterrupted or error-free, or that all software errors will be corrected.

 Tobii Dynavox does not warrant that the TD Pilot will meet Customer requirements, that the operation of the TD Pilot will be uninterrupted, or that the TD Pilot is free from bugs or other defects. Customer acknowledges that the TD Pilot will not function for all individuals and in all light conditions.

Please read this User's Manual carefully before using the device. The warranty is only valid if the device is used according to the User's Manual. Disassembling the TD Pilot Base will void the warranty.

 It is recommended to keep the original packaging materials for the TD Pilot.

If the device needs to be returned to Tobii Dynavox for Warranty-related issues or repair, it is beneficial that the original packaging or equivalent is used for shipping. Most shipping carriers require at least 2 inches of packing material around the device.

Note: Due to Joint Commission regulations, any shipping materials (including boxes) sent to Tobii Dynavox must be discarded.

A3 Training Resources

 No specific training is required for the safe and effective use of the primary operating functions of the TD Pilot.

Tobii Dynavox offers a range of training resources for the TD Pilot products and related communication products. You can find them on the Tobii Dynavox website, www.tobiidynavox.com, including Getting Started Guides, webinars and Software Training Cards. The TD Pilot Getting Started Guide and Software Training Cards are delivered with the TD Pilot device.

A4 Trouble-shooting Guide

A4.1 If the TD Pilot does not Power up

Connect the power supply and wait a couple of minutes to allow charging before trying to power up the device again. If the device does not start up correctly, please contact Customer Support. See *A1 Customer Support, page 35* for contact information.

A4.2 How do I carry out a Power Reset on the TD Pilot?

Hold down the power button of the device for 10 seconds. Doing so will power off the device regardless of what it was doing. To turn it back on, momentarily press the power button and the device will start up and turn on.



This will not reset the iPadOS device; that must be done as a separate step.

If the device does not start up correctly, please contact Customer Support. See *A1 Customer Support, page 35* for contact information.

A4.3 How can I tell if the TD Pilot Base is Connected to the iPadOS Device?

In iPadOS go to: **Settings > General > About**.

If the TD Pilot Base is powered on and properly connected to the iPad you should see Tobii Dynavox Pilot near the bottom.

A4.4 Refining Eye Gaze

If you are having difficulty using eye gaze with the TD Pilot, this list of common issues and solutions may help you. Try one or more of the solutions, since sometimes a combination results in successfully resolving the problem.

Issue	Solution
Eye tracker does not detect eyes.	<ul style="list-style-type: none"> • Be sure TD Pilot is charged and powered on. • Make sure AssistiveTouch is enabled, see <i>5.4.2 Setting up AssistiveTouch, page 19</i>. • Verify that the cable connecting the TD Pilot device to the iPad is securely plugged in . • Check positioning of device and person. • Review information on glare from glasses
Accuracy is not good.	<ul style="list-style-type: none"> • Check positioning of device and person, then recalibrate. • Review solutions for problems noted below. More than one may apply.
Accuracy gets worse over time.	<ul style="list-style-type: none"> • Recalibrate. Remember to check positioning before doing so. • Look away or close eyes for a moment to refocus. • Decrease brightness of display: iPad OS Settings > Display & Brightness • Increase the text size to make text-based targets larger: iPad OS Settings > Display & Brightness > Text Size • See "Experiencing eye strain or dryness" below.
Glare from glasses seems to be interfering.	<ul style="list-style-type: none"> • Clean glasses. • Limit or eliminate light coming from behind the person using the device. • If the user wears multifocal lenses, try repositioning the device to take advantage of the portion of the lens meant for computer use.
Pointer response lags.	<ul style="list-style-type: none"> • Increase Responsiveness setting: TD CoPilot Settings > AssistiveTouch
Difficulty holding dwell for sufficient time.	<ul style="list-style-type: none"> • Shorten dwell time: <ul style="list-style-type: none"> – <i>Assistive Touch</i>: iPad OS Settings > Accessibility > Touch > AssistiveTouch > Dwell Control Seconds – <i>TD Talk Keyboard Buttons</i>: TD Talk > Settings > Keyboard – <i>TD Talk Non-KeyBoard Buttons</i>: TD Talk > Settings > Activation – <i>TD Snap Global</i>: Edit > User > Access Method > Selection Type > Dwell Time – <i>TD Snap for Specific Buttons</i>: Edit > Select button(s) > Access Method > Dwell Time Turn off Match User settings > Dwell Time <div style="margin-top: 10px;"> Adjusting dwell time in iPadOS Settings affects AssistiveTouch only. Adjusting dwell time in TD Talk or TD Snap affects your communication software only. </div> <ul style="list-style-type: none"> • Increase Movement Tolerance: iPad OS Settings > Accessibility > Touch > AssistiveTouch • Decrease Responsiveness setting: TD CoPilot Settings > AssistiveTouch

Issue	Solution
<p>Selections happen too fast or accidentally.</p>	<ul style="list-style-type: none"> ● Lengthen dwell time: <ul style="list-style-type: none"> – <i>Assistive Touch</i>: iPad OS Settings > Accessibility > Touch > AssistiveTouch > Dwell Control Seconds – <i>TD Talk Keyboard Buttons</i>: TD Talk > Settings > Keyboard – <i>TD Talk Non-Keyboard Buttons</i>: TD Talk > Settings > Activation – <i>TD Snap Global</i>: Edit > User > Access Method > Selection Type > Dwell Time – <i>TD Snap for Specific Buttons</i>: Edit > Select button(s) > Access Method > Dwell Time > Turn off Match User settings > Dwell Time <p> Adjusting dwell time in iPadOS Settings affects AssistiveTouch only. Adjusting dwell time in TD Talk or TD Snap affects your communication software only.</p> <ul style="list-style-type: none"> ● Decrease Movement Tolerance: iPad OS Settings > Accessibility > Touch > AssistiveTouch
<p>Pointer is jumpy or drifts.</p>	<ul style="list-style-type: none"> ● Decrease Responsiveness setting: TD CoPilot Settings > AssistiveTouch ● Remove color from the Pointer: iPad OS Settings > Accessibility > Pointer Control > Color ● Adjust the size of the Pointer: iPad OS Settings > Accessibility > Pointer Control
<p>Cannot see Pointer.</p>	<ul style="list-style-type: none"> ● Modify the size and color of the Pointer to make it stand out: iPad OS Settings > Accessibility > Pointer Control
<p>AssistiveTouch Menu button interferes or distracts.</p>	<ul style="list-style-type: none"> ● Move the AssistiveTouch Menu button on the screen. ● Decrease Idle Opacity of the AssistiveTouch Menu button: iPad OS Settings > Accessibility > Touch > AssistiveTouch
<p>Feeling of motion sickness.</p>	<ul style="list-style-type: none"> ● Reduce Brightness of screen: iPad OS Settings > Display & Brightness ● Remove color from Pointer: iPad OS Settings > Accessibility > Pointer Control ● Enable Reduce Motion setting: iPad OS Settings > Accessibility > Motion ● Enable Prefer Cross-Fade Transitions setting: iPad OS Settings > Accessibility > Motion
<p>Experiencing eye strain or dryness.</p>	<ul style="list-style-type: none"> ● Take breaks. ● Reduce Brightness: iPad OS Settings > Display & Brightness ● Increase text size: iPad OS Settings > Display & Brightness > Text Size ● Consult physician.
<p>Eyes do not move together (strabismus).</p>	<ul style="list-style-type: none"> ● Identify the stronger eye and calibrate with that eye only. ● Consult physician.
<p>Involuntary eye movements (nystagmus).</p>	<ul style="list-style-type: none"> ● Reposition the device to see if there is an area in the visual field in which nystagmoid movement decreases.

Appendix B Compliance Information



The TD Pilot is CE-marked, indicating compliance with the essential health and safety requirements set out in European Directives.

B1 FCC Statement

This device complies with Part 15 of the FCC Rules. Operation is subject to the following two conditions: (1) this device may not cause harmful interference and (2) this device must accept any interference received, including interference that may cause undesired operation.



Modifications not expressly approved by Tobii Dynavox could void the user's authority to operate the equipment under FCC rules.

B1.1 For P15B Equipment

This equipment has been tested and found to comply with the limits for a Class B digital device, pursuant to part 15 of the FCC rules. These limits are designed to provide reasonable protection against harmful interference in a residential installation. This equipment generates, uses and can radiate radio frequency energy and, if not installed and used in accordance with the instructions, may cause harmful interference to radio communications.

However, there is no guarantee that interference will not occur in a particular installation. If this equipment does cause harmful interference to radio or television reception, which can be determined by turning the equipment off and on, the user is encouraged to try to correct the interference by one or more of the following measures:

- Reorient or relocate the receiving antenna.
- Increase the separation between the equipment and receiver.
- Connect the equipment into an outlet on a circuit different from that to which the receiver is connected.
- Consult the dealer or an experienced radio/TV technician for help.

B1.2 For Portable Devices

FCC RF Radiation Exposure Statement:

1. This Transmitter must not be co-located or operating in conjunction with any other antenna or transmitter.
2. This equipment complies with FCC RF radiation exposure limits set forth for an uncontrolled environment. This device was tested for typical hand held operations with the device contacted directly to the human body to the sides of the device. To maintain compliance with FCC RF exposure compliance requirements, avoid direct contact to the transmitting antenna during transmitting.

B2 CE Statement

This equipment complies with the requirements relating to electromagnetic compatibility, the essential protection requirement of Electromagnetic Compatibility (EMC) Directive 2014/30/EU on the approximation of the laws of the Member States relating to electromagnetic compatibility and Radio Equipment Directive (RED) 2014/53/EU to meet the regulation of the radio equipment and telecommunications terminal equipment.

B3 Directives and Standards

The TD Pilot complies with the following directives:

- Medical Device Regulation (EU) 2017/745
- Low voltage Directive 2014/35/EU
- Electromagnetic Compatibility (EMC) Directive 2014/30/EU
- Radio Equipment Directive (RED) 2014/53/EU
- RoHS2 Directive 2011/65/EU
- WEEE Directive 2012/19/EU
- Reach Directive 2006/121/EC, 1907/2006/EC Annex 17

- ISO 14971:2019
- ISO 13485:2016

The TD Pilot device has been tested to comply with IEC/EN 60601-1 Ed 3.1, IEC/EN 62368-1, ISO 14971:2019 and other relevant standards for the intended markets.

Appendix C Status LED Information

Table 1: LED Information

State		Meaning		
LED	Power Adapter Connected?	TD Pilot Power	TD Pilot Battery	iPad Battery
OFF	NO	OFF	Unknown	
OFF	YES		Charged	Unknown
BLUE	(YES)		Charging	Unknown
PULSING BLUE	(YES)	ON	Charging	
PULSING GREEN	YES		Charged	
PULSING GREEN	NO		Discharging	
RED	-	FAULT		

Appendix D Technical Specifications

D1 Standard TD Pilot

Standard	Tobii Dynavox TD Pilot
Type/Model	TD Pilot
iPadOS Device	Apple iPad Pro 12.9 5th gen 256 GB
Operating System	Apple iPadOS 15.1
Rear Display	480 × 128 pixels
Dimensions (WxHxD) TD Pilot	30,4 × 25,5 × 9,0 cm 12.0 × 10.0 × 3.5 inches
Dimensions (WxHxD) TD Pilot Base	28,8 × 20,4 × 9,0 cm 11.3 × 8.0 × 3.5 inches
Weight TD Pilot	2,0 kg 4,4 lbs
Weight TD Pilot Base	1.2 kg 2.7 lbs
Speakers	2 × 10 W Closed Box Speakers
Connectors	1 × Thunderbolt/USB 4 (iPadOS device) 1 × USB-C 2 × 3.5 mm Switch connector interface, (Pin out for mono plug: Sleeve = Common ground, Tip = Signal) 1 × 3.5 mm" Headphone jack (stereo) with jack detection 1 × 15 VDC in 1.65/4 mm (Power connector)
Buttons	1 × Top button (iPadOS device) 1 × Volume up/down (iPadOS device) 1 × Power On 1 × Track Status
Eye Tracker (optional)	Tobii IS5TDL Module
Expected Service Life	5 years
Typical Average Battery Run Time	~10 h
Battery Charge Time	Maximum 4 h (10-90%)
Deskstand	Integrated
Mounting Systems Supported	Tobii Dynavox QR adapter plate for Daessy and REHAdapt
Power Supply	65 W AC adapter
IP class	IP53 Pass for device only, with I/O covers in place. IP22 Without I/O covers.

D2 Device Power Adapter

Item	Specification
Manufacturer	Mascot AS
Type	3320–15

Item	Specification
Model	3320
Input voltage	90 to 264 VAC
Input current (max)	1.5 A
Input frequency	50 to 60 Hz
Output current	4 A
Rated output voltage	15.0 VDC

D3 Battery pack

Item	Specification	Remark
Battery Technology	Li-Ion rechargeable battery pack with gas gauge (SMBus v1.1 interface)	
Cell	6× NCR18650GA	
Battery Pack Capacity	71,28 Wh	Initial capacity, new battery pack
Nominal Voltage	10.8 Vdc, 6600mAh	
Charge Time	Maximum 4 h	Charge from 10 to 90%
Cycle Life	300 cycles	Minimum 75% of initial capacity remaining
Allowable Operating Temperature	0 – 45 °C, 45-85%RH	Charge condition
	-20 – 60 °C, 45-85%RH	Discharge condition
Storage Temperature	-20 – 35 °C, 45-85%RH	1 year
	-20 – 40 °C, 45-85%RH	6 months
	-20 – 45 °C, 45-85%RH	1 month
	-20 – 50 °C, 45-85%RH	1 week
Storage Time ¹	Maximum 6 months @ charge ≥ 40%	 Do not store battery packs for a long time with less than 40% charge level.

1. It is recommended that the battery shall not be stored in the device if the device is not going to be used within 6 months. If the battery is removed, the battery will not be drained as quickly as when stored in the device.

D4 Eye Tracker

If installed

Technical Specifications	Tobii IS5TDL Module
Working Distance	45 — 95 cm 20 — 37 inches
Freedom of Head Movement ¹ (Width x Height)	~20 × 20cm (7.9 × 7.9 inches) @ 50 cm from screen ~35 × 35 cm (13.8 × 13.8 inches) between 65 – 80 cm from screen
Positioning	
Distance (from screen)	45 — 95 cm (20 — 37 in)
Track box size (Width × Height)	20 × 20 — 35 × 35 cm (7.9 × 7.9 — 13.8 × 13.8 in)
Track box depth	50 cm (19.7 in)
Gaze Data Rate	33 Hz
Gaze Sample Rate	133 Hz
Eye tracking technique	Video-based pupil- and corneal- reflection eye tracking with dark and bright pupil illumination modes.
Outdoor Usage Possible	Yes

Technical Specifications	Tobii IS5TDL Module
User Calibration (former tracking robustness)	>98%
Detect Gaze Interaction >30Hz	98% for 95% of population ²
Gaze Accuracy Across 95% of population ³	<1.58 degrees
Gaze Precision Across 95% of population ³	<0.2°
Max Head Movement Speed Eye Position Gaze Data	40 cm/s (15.7 in/s) 10 cm/s (3.9 in/s)
Max Head Tilt	25°
Max Yaw, pitch	25°
Data Flow and Data Rate Gaze Latency Gaze Recovery	17 ms 0 ms
Mounting	Built-in
Power Supply	Built-in
<p>1. Freedom of head movement describes the volume in front of the tracker in which the user must have at least one of the eyes. The numbers are specified parallel/orthogonal to screen surface.</p> <p>2. The test population excluded those who would wear correctional glasses with a +5.00 diopter or higher or suffer from an eye disease.</p> <p>3. The degree-of-accuracy and precision over percentage-of-population numbers result from extensive testing across representatives of the whole population. We have made use of hundreds of thousands of diagnostic images and performed tests on approximately 800 individuals with different conditions, vision, ethnicities, everyday dust, smudges or blemishes around their eyes, with eyes out of focus, etc. This has resulted in a much more robust and high-performance eye tracking experience and a much more realistic representation of true performance across the whole population, not just in a mathematically “ideal” scenario.</p> <p>The “ideal” degree numbers are the previous standard of measuring accuracy and precision, both previously from Tobii and presently from all eye tracking competitors. Though “ideal” numbers are useful to get a general feel about comparative quality and performance, they are not applicable to real world usage in the same way as quantitative degree-of-accuracy and precision over percentage-of-population numbers based on extensive testing across representatives of the whole population.</p>	

Appendix E Guidance and Manufacturer's Declaration

Below cables information are provided for EMC reference

Cable	Max. cable length	Shielded/unshielded	Number	Cable classification
AC Power Cord	0.9 m	Unshielded	1 Set	AC Power
DC Power Cord	1.15 m	Shielded	1 Set	DC Power
Two Switch Button Cables	1.44 m	Shielded	1 Set	Signal
USB cable	0.26 m	Shielded	1 Set	Signal

Important information regarding Electro Magnetic Compatibility (EMC)

This electrical medical equipment needs special precautions regarding EMC and put into service according to the EMC information provided in the user manual; The equipment conforms to this IEC 60601-1-2:2014 standard for both immunity and emissions. Nevertheless, special precautions need to be observed:

- The equipment with no ESSENTIAL PERFORMANCE is intended used in Home healthcare environment.
- **WARNING:** Use of this equipment adjacent to or stacked with other equipment should be avoided because it could result in improper operation. If such use is necessary, this equipment and the other equipment should be observed to verify that they are operating normally”.
- The use of accessories, transducers and cables other than those specified or provided by the manufacturer of this equipment could result in increased electromagnetic emissions or decreased electromagnetic immunity of this equipment and result in improper operation.
- **WARNING:** Portable RF communications equipment (including peripherals such as antenna cables and external antennas) should be used no closer than 30 cm (12 inches) to any part of the TD Pilot, including cables specified by the manufacturer. Otherwise, degradation of the performance of this equipment could result.”
- **WARNING:** If the use location is near (e.g. less than 1.5 km from) AM, FM or TV broadcast antennas, before using this equipment, it should be observed to verify that it is operating normally to assure that the equipment remains safe with regard to electromagnetic disturbances throughout the expected service life.

 **STATEMENT:** For the purpose of its operation, the equipment has wireless communication function, it includes RF transmitter and receiver, 2.4 GHz, Pulse modulation.

 **STATEMENT:** The equipment is designed compatible with high frequency surgical equipment; the condition includes working or standby in close proximity to high frequency surgical equipment.

Table 2: EMI Compliance Table — Emission

Phenomenon	Compliance	Electromagnetic environment
RF emissions	CISPR 11 Group 1, Class B	Home healthcare environment
Harmonic distortion	IEC 61000-3-2 Class A	Home healthcare environment
Voltage fluctuations and flicker	IEC 61000-3-3 Compliance	Home healthcare environment

Table 3: EMS Compliance Table — Enclosure Port

Phenomenon	Basic EMC standard	Immunity test levels
		Home healthcare environment
Electrostatic Discharge	IEC 61000-4-2	±8 kV contact ±2kV, ±4kV, ±8kV, ±15kV air
Radiated RF EM field	IEC 61000-4-3	10 V/m 80MHz-2.7GHz 80% AM at 1kHz
Proximity fields from RF wireless communications equipment	IEC 61000-4-3	Refer to table

Phenomenon	Basic EMC standard	Immunity test levels
		Home healthcare environment
Rated power frequency magnetic fields	IEC 61000-4-8	30A/m 50Hz or 60Hz

Table 4: EMS Compliance Table — Proximity fields from RF wireless communications equipment

Test frequency (MHz)	Band (MHz)	Immunity test levels
		Home healthcare environment
385	380-390	Pulse modulation 18Hz, 27V/m
450	430-470	FM, ± 5 kHz deviation, 1kHz sine, 28V/m
710	704-787	Pulse modulation 217Hz, 9V/m
745		
780		
810	800-960	Pulse modulation 18Hz, 28V/m
870		
930		
1720	1700-1990	Pulse modulation 217Hz, 28V/m
1845		
1970		
2450	2400-2570	Pulse modulation 217Hz, 28V/m
5240	5100-5800	Pulse modulation 217Hz, 9V/m
5500		
5785		

Table 5: EMS Compliance Table — Input a.c. power Port

Phenomenon	Basic EMC standard	Immunity test levels
		Home healthcare environment
Electrical fast transients/burst	IEC 61000-4-4	± 2 kV 100 kHz repetition frequency
Surges Line-to-line	IEC 61000-4-5	± 0.5 kV, ± 1 kV
Conducted disturbances induced by RF fields	IEC 61000-4-6	3V, 0.15 MHz - 80 MHz 6 V in ISM bands and amateur radio bands between 0.15 MHz and 80 MHz 80% AM at 1 kHz
Voltage dips	IEC 61000-4-11	0% U_T ; 0.5 cycle At 0°, 45°, 90°, 135°, 180°, 225°, 270° and 315°
		0% U_T ; 1 cycle and 70% U_T ; 25/30 cycles Single phase: at 0°
Voltage interruptions	IEC 61000-4-11	0% U_T ; 250/300 cycles

Table 6: EMS Compliance Table — Signal input/output parts Port

Phenomenon	Basic EMC standard	Immunity test levels
		Home healthcare environment
Conducted disturbances induced by RF fields	IEC 61000-4-6	3V, 0.15 MHz - 80 MHz 6 V in ISM bands and amateur radio bands between 0.15 MHz and 80 MHz 80% AM at 1 kHz

Appendix F Approved Accessories

Description	Model	Tobii Dynavox Part No.
TD Pilot AC Adapter (Power Supply)	Mascot 3320	13000412
Battery pack	TDBW1	13000162
Eye Gaze for TD Pilot	Tobii IS5L Module	520223

For information about the latest approved Tobii Dynavox Accessories, please visit the www.tobiidynavox.com website or contact your local Tobii Dynavox reseller.

Appendix G Local Certification Partners

The listed companies are the partners for our local certifications in their countries.

Contact Information:

Link Assistive Pty Ltd
43 Adelaide Tce
Pasadena SA, 5042
Australia
+61 8 7120 6002

SOLUCIONES EN TECNOLOGÍA ADAPTADA MEXICO
S.A DE C.V
Av. Rio Mixcoac 164 Col. Acacias Del Valle Deleg
Benito Juarez. CP. 03240
Mexico
+1-800-344-1778

Swiss Authorized Representative

MedEnvoy Switzerland
Gotthardstrasse 28
6302 Zug
Switzerland
+41 41 562 01 42

Copyright © Tobii Dynavox AB (Publ). Not all products and services offered in each local market. Specifications are subject to change without prior notice. All trademarks are the property of their respective owners.

Support for Your Tobii Dynavox Device

Get Help Online

See the product-specific Support page for your Tobii Dynavox device. It contains up-to-date information about issues and tips & tricks related to the product. Find our Support pages online at: www.TobiiDynavox.com/support-training

Contact Your Solution Consultant or Reseller

For questions or problems with your product, contact your Tobii Dynavox solution consultant or authorized reseller for assistance. They are most familiar with your personal setup and can best help you with tips and product training. For contact details, visit www.TobiiDynavox.com/contact