



**Mounting. Anything. Anywhere.**  
*...for more than 20 years*



## Components

# Your competent mounting partner

Benefit from Rehadapt as your competent mounting partner for **medical devices** and more!

For two decades, Rehadapt has been globally recognized for mounting systems that securely **position assistive technologies** for optimal user experience. Our extensive experience in the me-

dical device sector makes us the ideal partner for **all types of professional mounting requirements**.

The individual needs of our users have driven the development of the most **comprehensive modular system** for mounting solutions worldwide.



## Perfect for:

- ✓ Environmental controls
- ✓ Speech devices
- ✓ iPads
- ✓ Smartphones
- ✓ Monitors
- ✓ ventilation hose
- ✓ ventilation equipment
- ✓ stationary pulse oxymeter
- ✓ blood pressure monitoring equipment
- ✓ long-term ECGs
- ✓ Input devices
- ✓ Storage systems
- ✓ Tool holders
- ✓ Lighting
- and much more...

## In the following areas:

- ✓ in medical sector
- ✓ in laboratory settings
- ✓ in the rehabilitation sector
- ✓ in the care environment
- ✓ in workshops
- ✓ MDR-compliant

If you would like to learn more about Rehadapt mounting systems in the care sector or if you are looking for a custom clamp for your product, please feel free to contact us. We mount anything anywhere!

## Rehadapt Headquarters

Rehadapt Engineering GmbH & Co. KG  
Heinrich-Hertz-Str. 104  
34123 Kassel, Germany  
Fax +49 561 220 717 0  
Fon +49 561 220 717 99  
officeteam@rehadapt.com



**Robert Kohls**  
Director of Sales & Training Europe  
[robert.kohls@rehadapt.com](mailto:robert.kohls@rehadapt.com)

## Rehadapt North America

Rehadapt North America LLC  
40 Oser Ave, Suite 40-01  
Hauppauge, NY 11788, USA  
Fax +1 888 635 6962  
Fon +1 888 635 6962  
officeteam.na@rehadapt.com



**Maggie Mahoney**  
CEO Rehadapt North America  
[maggie.mahoney@rehadapt.com](mailto:maggie.mahoney@rehadapt.com)

# Content

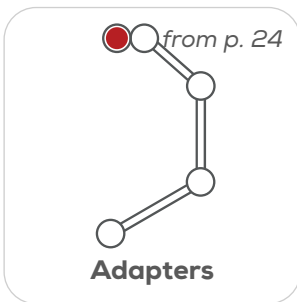
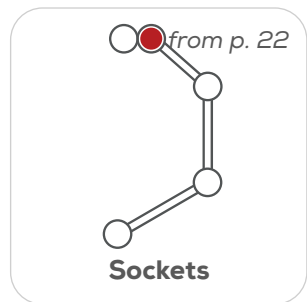
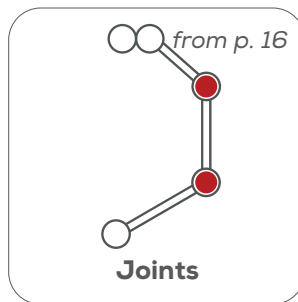
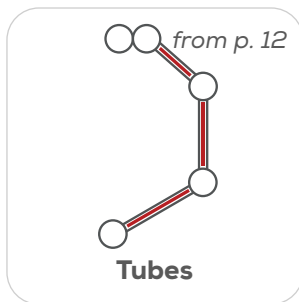
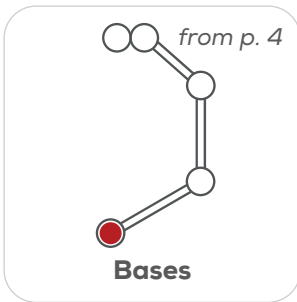

## With Rehadapt you are not on your own

Using state-of-the-art technology and a **well-thought-out modular system**, we assist users and professionals in finding the optimal mounting solution. In doing so, we emphasize making the supply process as straightforward as possible.

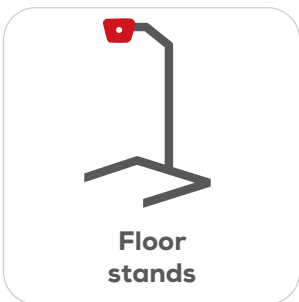

With our wide range of services, you've got a dedicated team at your side. Furthermore we ensure that all of our partners are skilled and have 24/7 access to all necessary information and materials for training for the right usage of our products.

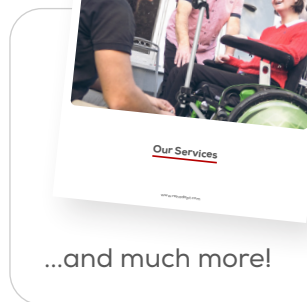
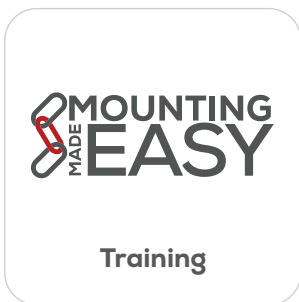



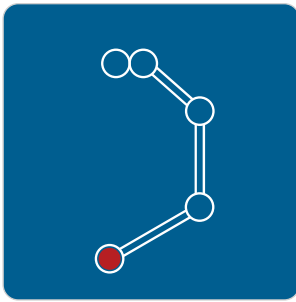

# Bases

Rehadapt offers the highest precision for clamping on a plethora of wheelchair frames with different profiles, diameters and sizes. Each base consists of two or three parts. There is always a frameclamp and a tube socket. Optionally you can add extensions in-between like offset spacers, a 90° angle or a coupler.

## Overview

Create your individual frame clamp from various components to fit every need. Or choose from **pre-configured** complete bases ready to use on standard situations **from page 11**.

from p. 5

**Frame clamps**

Base-half clamping directly on the wheelchair frame.



Round



closed



semi-open



Rectangular



Rails



Holes



on flat surfaces



on tubes

from p. 8

**Extensions**

Choose between offset spacers, 90° angle or coupler.



Coupler



Angle

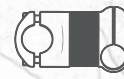

Spacer

from p. 9

**Tube sockets**

Base-half clamping the first tube of your mounting system.



Single tube



Double tube



Swivel halves

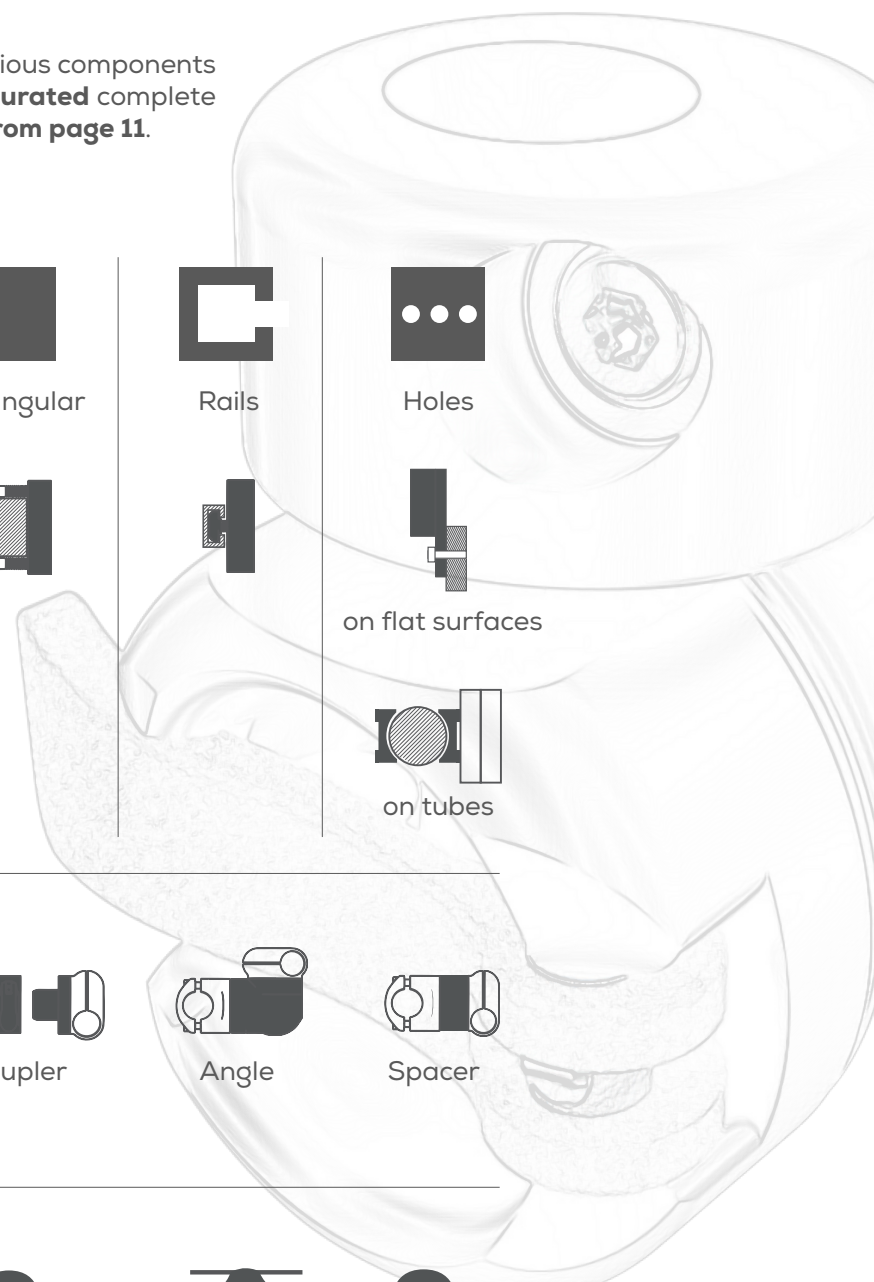



# Round frame clamps

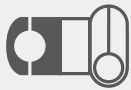

**Closed** sockets for wheelchair frames with a round profile.

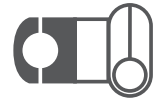

**Frame clamps**



## M3D RKL

Readapt standard frame clamp for use in most common situations. Extendable with different sleeves to fit especially small or oval-shaped tube profiles.

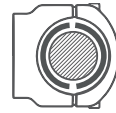

Circular sleeves for use within the M3D RKL25 (11.1125)



Ø in mm	SKU
25	11.1125
26	11.1126
27/28	11.1128
29	11.1129
30	11.1130
31/32	11.1132
33/34	11.1134

Ø in mm	SKU
35	11.1135
36	11.1136
37/38	11.1138
39/40	11.1140
41/42	11.1142
44/45	11.1145

Ø in mm	Sleeves only	with M3D RKL 25
19	01.2519	11.1119
20	01.2520	11.1120
21	01.2521	11.1121
22	01.2522	11.1122
23	01.2523	11.1123



## M3D RKL Kimba Neo

11.1071

Monty 3D frame clamp specially designed for the oval tube of the „Kimba Neo“ stroller from OttoBock.



Oval sleeves only for use within stated frame clamps.

Sleeves only

with frame clamp

	Sleeves only	with frame clamp
<b>Frame Sleeve Sunrise Medical</b> Adapter sleeve to mount the M3D RKL 36 (11.1136) on Sunrise Medical wheelchairs with oval frame tubes 33 x 26.5 mm (e.g. Zippie Zone).	 01.3633	 11.1192
<b>Frame Sleeve Leggero</b> Adapter sleeve to mount the M3D RKL 36 (11.1136) on Leggero strollers with oval frame tubes 35 x 22 mm (e.g. Trak).	 01.3635	 11.1193
<b>Frame Sleeve R82 Multiframe</b> Adapter sleeve to mount the M3D RKL 40 (11.1140) on R82 wheelchairs with oval frame tubes 40 x 21 mm (e.g. Multiframe).	 01.4021	 11.1194
<b>Frame Sleeve Rifton Pacer</b> Adapter sleeve to mount the M3D RKL 45 (11.1145) on Rifton Pacer gait trainers with oval frame tubes 44.5 x 22 mm.	 01.3634	 11.1195

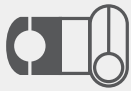

**Semi-open** socket. Applicable when the frame tube is partially obstructed (e.g. overlying seat).

### M3D RKL-T

Readapt semi-opened clamp for use in situations when the tube is not fully accessible (e.g. directly under the seat). Not compatible with sleeves.



### M3D RKL-Madita-Fun 11.1079

Monty 3D frame clamp for the armrest of the „Madita-Fun“ therapy chair from „Schuchmann“ (racetrack-shaped profile of 35 x 20 mm).

Ø in mm	SKU	Ø in mm	SKU	Ø in mm	SKU
16	11.1416	23	11.1423	28	11.1428
19	11.1419	24	11.1424	29	11.1429
20	11.1420	25	11.1425	30	11.1430
21	11.1421	26	11.1426	32	11.1432
22	11.1422	27	11.1427		

## Rectangular frame clamps



### M3D RKL-E30 11.1065

Monty 3D frame clamp for rectangular wheelchair frame elements up to 30 mm (1 3/16“) thick.

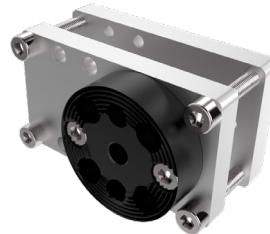

### M3D RKL-E30-70 11.1060

Monty 3D frame clamp for rectangular wheelchair frame elements from 30-70 mm (1 3/16“ – 2 3/4“) thick.

## Frame clamps for threaded holes

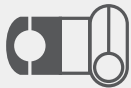

Frame clamps for mounting on **flat surfaces** or rectangular tubes with threaded holes.

### M3D Adapter Ring

11.1074

Monty 3D base mounting adapter to bolt to any flat surface. Combine with a Base Special or a Swivel Special to build a full unit. Can also be used as a T-track

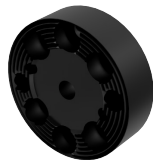

### M3D RKL M6

11.1073

Monty 3D special frame clamp with M6 bolts for wheelchair frames with Ø6mm holes or M6 threads.

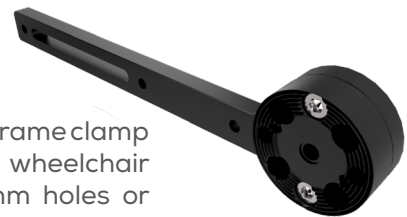

### M3D RKL M8

11.1070

Monty 3D special frame clamp with M8 bolts for wheelchair frames with Ø8mm holes or M8 threads.



### M3D RAD-Per Uni

11.1062

Universal Monty 3D Permobil frame clamp for the following Permobil chairs & seats:

Hexior, Canto, Corpus, Corpus Jr, Vertical, Stander, KB, Lowrider, Chairman, HD, Street, Miniflex, Koala, Playman, Robo.



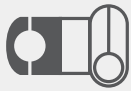

**Saddle washers** for mounting a flat frame clamp on a wheelchair tube with holes.



### M3D RKL M8 Mini

11.1075

Monty 3D special frame clamp with M6 and M8 bolts for wheelchair frames with  $\varnothing 6$  and 8mm holes (e.g. under the tie-down bracket). Saddle washers for tubes with  $\varnothing 22$  and  $\varnothing 25$  mm included.

#### Set of saddle washers

Set of four 4 saddle washers. For  $\varnothing 6 - 8$  mm holes. Bolts and other fastening elements included.



$\varnothing$ in mm	SKU
22	01.3022
25	01.3025

## Frame clamps for T-nut rails

### M3D T-Nut 16 x 6.5

11.1069

Monty 3D T-nut frame clamp for C-Profile railing max. 16 x 6.5 mm (15/16" x 1/4"). Suitable for the powered wheelchairs from „Quantum“ or „Invacare“.



### M3D Permobil UniTrack

11.1068

Monty 3D frame clamp for Permobil UniTrack rail / double T-nut system.



### M3D RKL T-Nut Karma

11.1064

Monty 3D T-nut frame adapter for C-profile railing max 11.5 x 4 mm (W x H). Suitable for mounting under the armrest or rail of powered wheelchairs from Karma - Life & Mobility Group (e.g. Evo Lectus).



### M3D T-Nut 10.5 x 4

11.1077

Monty 3D T-nut frame clamp for C-Profile railing max. 10.5 x 4 mm (13/32" x 5/32"). Suitable for the „Quickie“ powered wheelchair from „Sunrise Medical“.



### M3D T-Nut 23 x 7

11.1066

Monty 3D T-nut frame clamp for C-Profile railing max. 23 x 7 mm (15/16" x 1/4"). Suitable for the powered wheelchair from „ETAC“ Balder.



### M3D Item P5

11.1072

Monty 3D frame clamp for wheelchairs with Item profil 5 railing. Suitable for some powered wheelchairs from „SKS Rehab“.



### M3D RKL T-Nut Sunrise Medical

11.1067

Monty 3D T-nut frame adapter for T-nut tracks from Sunrise Medical. Suitable for the „Q400“, „Q500“, „Q700“, „Puma 40“, „Ibis“ and „Jive M2“ powered wheelchairs with „SEDEO ERGO“, „PRO“ or „LITE“ seats.



## Coupler

### M3D Base Coupler

11.1555

Coupler to easily remove the entire mount at the frame clamp. Precise alignment achieved through a racetrack-shaped connection. Hand lever and locking pin for maximum safety. Adds a 38mm offset (1.5").



**M3D Base Coupler Inner Part**  
11.1553

Attached to the wheelchair

**M3D Base Coupler Outer Part**  
11.1554

Attached to the mount

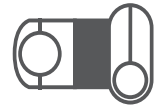

Extensions

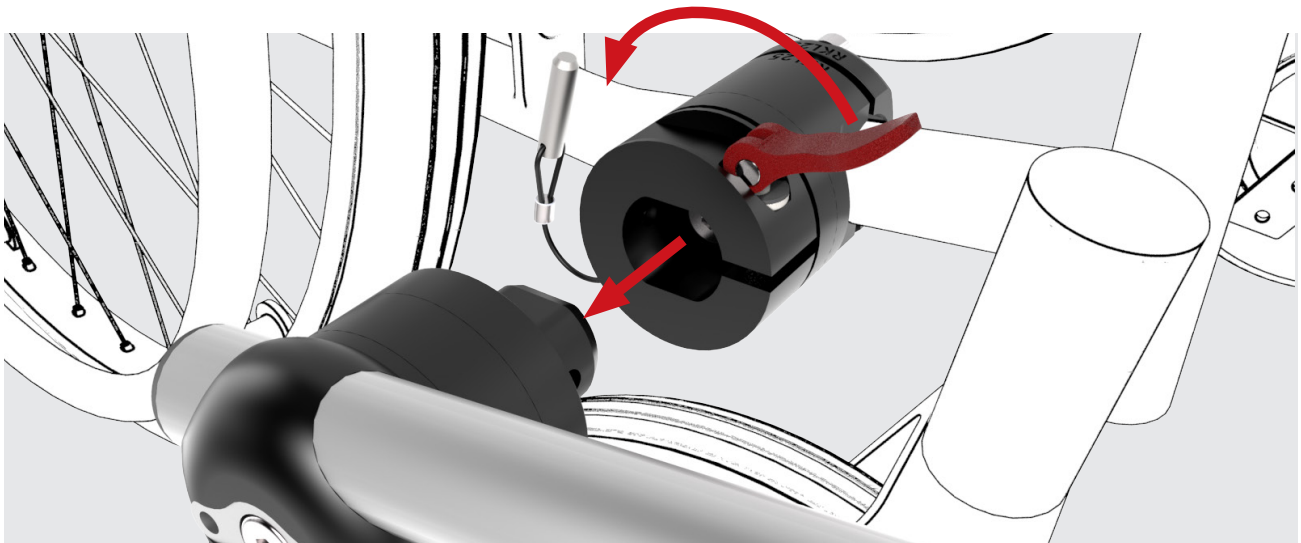

## Spacers

Monty 3D universal offset spacers are connectors that allow to gain more distance from the frame clamp when the wheelchair frame or accessories like breaks are in the way. To be applied between any mating M3D joint, base or swivel unit components. Can be daisy-chained with second spacer.



**M3D Offset link 1"**

11.1525

offset spacer  
25mm (1")



**M3D Offset link 1 1/2"**

11.1538

offset spacer  
38mm (1 1/2")

## Angle

### M3D Base Adapter 90°

11.1590

Perpendicular connector that allows the attachment of M3D and L3D mounts on otherwise poorly accessible frame parts. Locking with Allen screws.

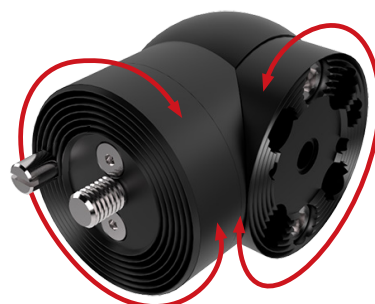

Allows full  
3D adjustability  
of the base

## Single tube sockets

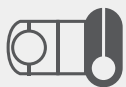

Mount-side halves for clamping one tube and combine to any frame clamp (not included) to build an individual base unit.



Tube sockets

### Rotation lock



\*rotation lock elements to prevent the mount from sagging when carrying heavy loads or when the mount is attached to the left side of the wheelchair.



**M3D Tube Socket**  
11.1102



**M3D Tube Socket Lock**  
11.1106  
with additional screw



**M3D Tube Socket Rotation Lock**  
11.1080  
with RotLock\*



**L3D10 Tube Socket**  
14.1119  
for L3D10 tubes



**L3D16 Tube Socket**  
14.1101  
for L3D16 tubes



**L3D16 Tube Socket QS**  
14.1155  
with QuickShift lever  
for L3D16 tubes

## Double tube sockets



Mount-side half for clamping double tubes and combine to any frame clamp (not included) to build an individual base unit.



**M3D Tube Socket Rotation Lock HD**  
11.1081  
Monty 3D double tube rotation lock element for base unit to prevent the mount from sagging when carrying heavy loads.



**M3D Connector HD**  
11.1500  
Monty 3D connector HD. Connects the parallel tube's that build HD double-tube systems.

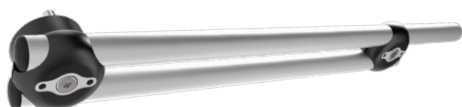

**M3D HD Upgrade-kit**  
11.1403

Monty 3D upgrade kit to equip any M3D mount with a double tube. Significantly reduces vibration, allows for heavy devices on long mounts.



## Swivel halves



Mount-side halves of swivel units. Combine with any frame clamp to build an individual swivel unit attached directly to the wheelchair.



**M3D Tube Socket Swivel-Joint-S**  
11.1222

backlash-free



**M3D Tube Socket Swivel-Joint-S + Index**  
11.1223

backlash-free with indexing slot



**M3D Tube Socket Rotation Lock Swivel-Joint S**  
11.1082

backlash-free with indexing slot with RotLock



**M3D Tube Socket Swivel-Joint**  
11.1214

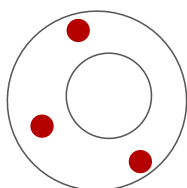

**M3D Tube Socket Swivel-Joint + Index**  
11.1213  
with indexing latch



**L3D16 Tube Socket Swivel Unit S**  
14.1221

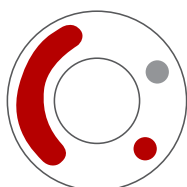

**L3D16 Tube Socket Swivel Unit S + Index**  
14.1223  
with indexing slot

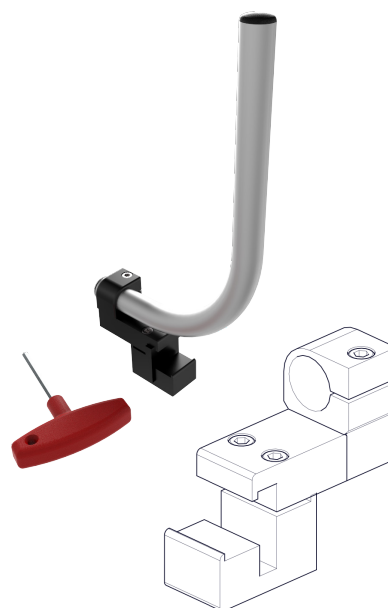

**M3D RKL Care Bed Dali/Lippe**  
11.1040

Monty 3D frame clamp for the bed base frame, compatible with the Dali and Lippe care beds from Burmeier. It includes an L-shaped tube that wraps around the mattress and a frame clamp that serves as the foundation for mounting.



## Pre-configurations



### L3D 10-Bases

Light 3D 10 base unit. Connector Ø10 mm (3/8") tubes with frame clamp for round wheelchair tubes with different diameters.

Ø in mm	SKU
10 - 10,5 mm (7/16")	14.1111
11 - 11,5 mm (7/16")	14.1115
12 - 13 mm (½")	14.1110
14 mm (9/16")	14.1114
15 mm (9/16")	14.1112
16 mm (5/8")	14.1113



### L3D 10-Base E16

14.1116

Light 3D 10 base unit with frame clamp for rectangular elements from Ø10-16 mm (3/8-5/8") wide. Holds L3D Ø10 mm (3/8") tubes.



### M3D Base SuperClamp

12.1000

Versatile SuperClamp with tube socket for Ø22mm (7/8") tubes. Horizontal 360° rotation adjustable with a QuickShift lever.



### Plastic wedge for the SuperClamp

01.0999

Replacement wedge for the SuperClamp (e.g. 12.1000, 14.1171 or 14.1173).



with additional QuickShift joint

Ø in mm	SKU
16 mm → 16 mm	14.1171
16 mm → 10 mm	14.1173



### L3D 10 MiniClamp QS

14.1174

Small universal tube clamp for Ø13-35mm tubes (½" - 1 3/8") with rubberized clutches. Rubber wedge for flat surfaces included. Quick fixation with clamping lever. Includes a L3D10 QS joint.



### Rubber wedge for the MiniClamp

01.0132

Replacement wedge for the MiniClamp (e.g. 14.1174).

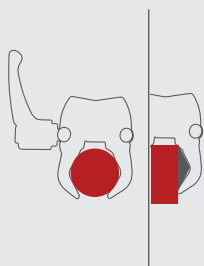

### MiniClamp

Quick to attach & detach and less bulky - ideal for round or oval tubes of typical wheelchair frame diameters from 13 to 35mm (½" to 1 3/8"). It comes with rubberized clutches and additional inlays to fit even on rectangular tubes. Optimal for lightweight items such as switches.

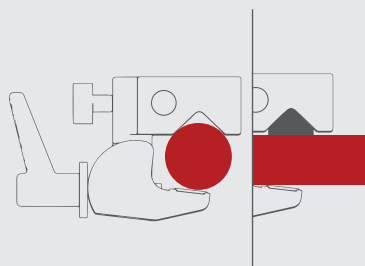

### SuperClamp

Our SuperClamps mount onto both rectangular and round structures e.g. boards or tubes with a diameter/thickness of 13 mm to 50 mm (½" - 2"). Ideal for tables or lap trays for a quick yet sturdy solution.

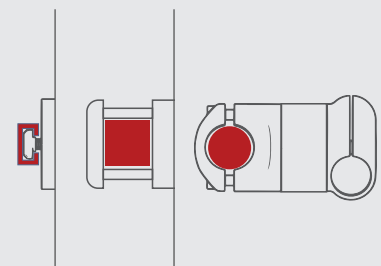

### Frame clamps

Rehadapt offers the highest precision for clamping on a plethora of wheelchair frames with different profiles, diameters and sizes. Frame clamps offer the most stable mounting option and are designed to fit exactly to the according wheelchair frame. Perfect for fixed and durable mounting solutions.

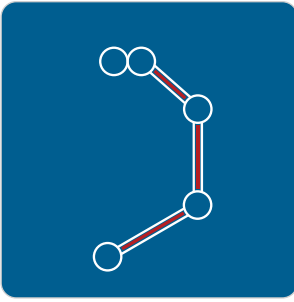

# Tubes

Rehadapt offers tubes with different diameters and shapes for the M3D, H3D and L3D lines of products. All tubes are made of aircraft-grade aluminium. That makes them extremely sturdy while maintaining a light weight and absolutely even surface. Their perfectly round precision manufacturing translates into maximum force fit at any clamp.

## Overview

Rehadapt uses tubes with different diameters, shapes, functionality and accessories to build with ease the most flexible and sturdy mounting solution possible.

### Diameters



L3D10  
Ø 10 mm  
(3/8")

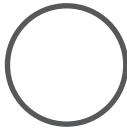

L3D16  
Ø 16 mm  
(5/8")

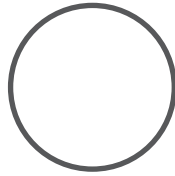

M3D22  
Ø 22 mm  
(7/8")

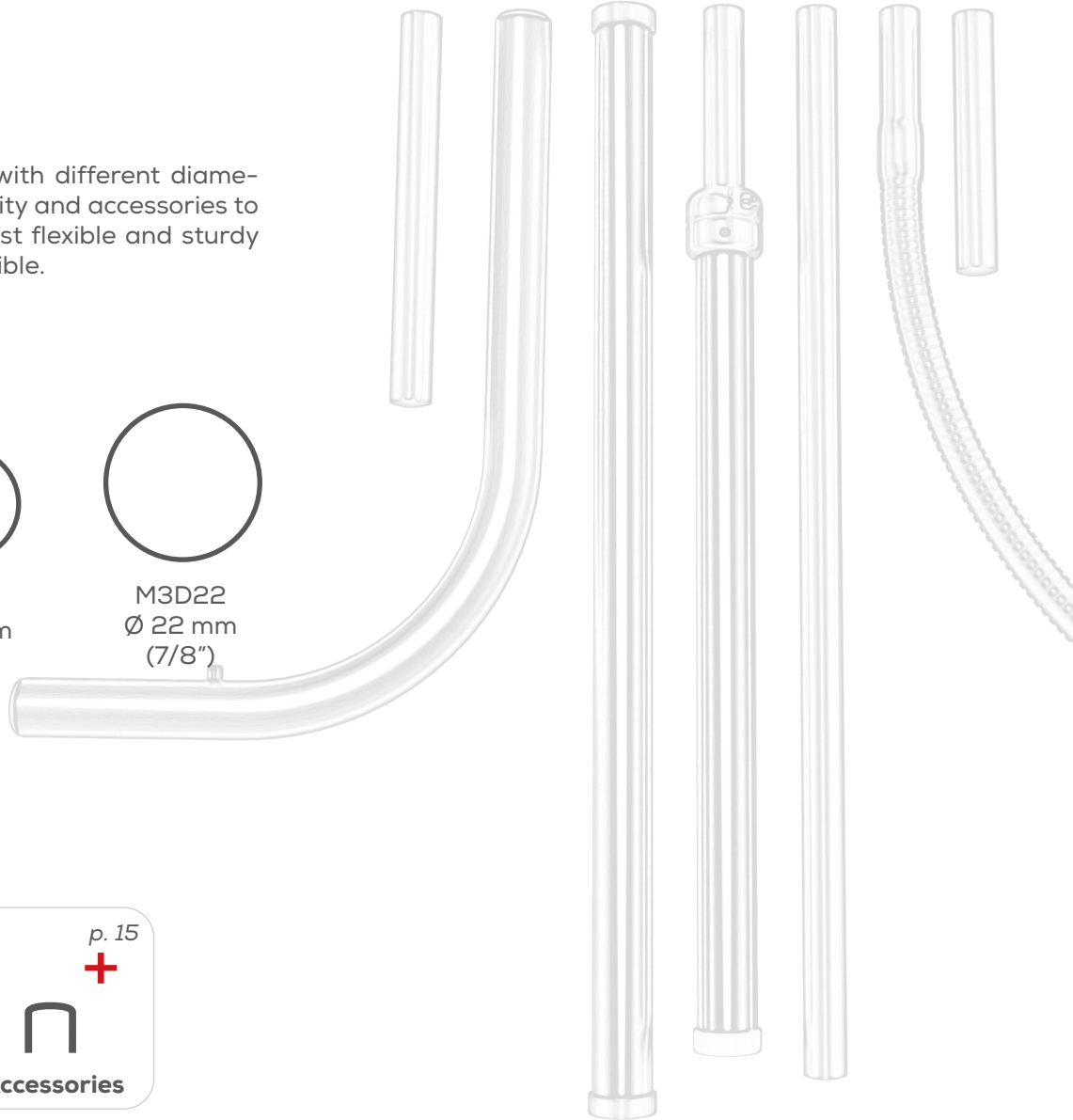

### Shapes & Extras

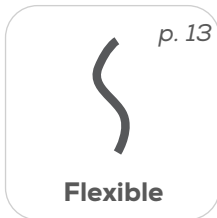
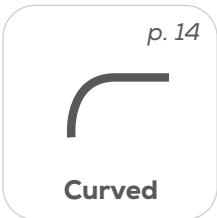

## Straight tubes

				
Length	M3D22	M3D22*	L3D16	L3D10
100 mm (4")			14.9500	14.9512
150 mm (6")			14.9501	14.9513
200 mm (8")	01.5005	01.5505	14.9502	14.9514
250 mm (10")			14.9503	14.9515
300 mm (12")	01.5010	01.5510	14.9504	14.9516
350 mm (14")			14.9505	14.9517
400 mm (16")	01.5020	01.5520	14.9506	
500 mm (20")	01.5030	01.5530		
600 mm (24")	01.5031			

\*slip-out safeguards included

## Flexible tubes

Flexible tubes for casual positioning, quick adjustments and injury prevention.

### Flex tubes

Light 3D flex-tube with a diameter of 16 mm (5/8") for quick casual adjustments of lightweight devices with a maximum load capacity of 1.2kg or 2.5lbs (can be reduced in vibrating environments).

01.6015 Tube length: 350mm (14")

01.6016 Tube length: 500mm (20")



### Flex back tube

Flexible L3D / switch mount tube with a diameter of 10mm. Always springs back to its origin! Perfect for compensating uncontrolled movements. Prevents injuries and damage.

14.9713 Tube length: 15 cm / 6"

14.9714 Tube length: 25 cm / 10"

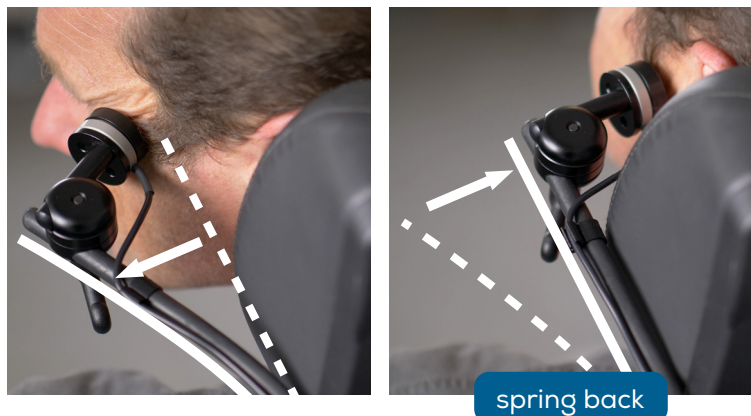

### Telescopic tube

13.9505

Hybrid 3D telescopic tube. Extendable length: 400-650mm (16" - 26"). Diameters: 22 and 16mm (7/8" and 5/8"). Defined length fixed with a bolt. Allen wrench included. Maximum load: 1.8kg (4.0lbs).





## Curved tubes

### L-Tubes

L-curved tube with a diameter of 22 mm (7/8") for an angled positioning without the need of an additional joint.



	Height	Offset
12.5403	275mm (11")	190mm (7,5")
12.5409*	270mm (10.6")	170mm (6.7")

\*Slip-out safeguards included

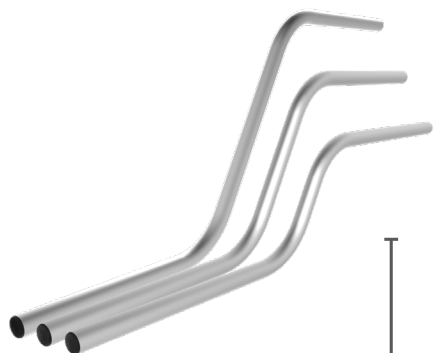

### S-Tubes

S-curved tubes with a diameter of 22,25 mm (7/8") for extra clearance and offset without the need of additional joints.

Length/Offset

660 mm (26")	152 mm (6")	01.5650	01.5660	
762 mm (30")	228 mm (9")	01.5662	01.5664	01.5670
863 mm (34")				01.5680
965 mm (38")				01.5690

## Tube accessories

Rehadapt tubes are made of aircraft-grade aluminium and can be expanded in their functionality by adding different accessories.

### End plugs



#### Slip-out safeguards

01.5500

Two slip-out safeguards with screws for  $\varnothing$  22,25 mm (7/8") tubes (thickness: 2,3 mm). Allen wrench not included.

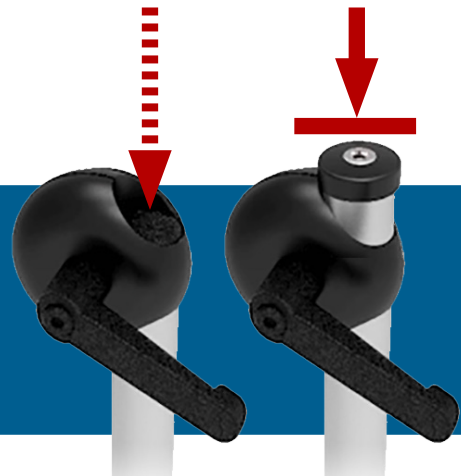

#### Standard end plugs

for L3D16 01.5998  
for M3D22 01.5999



#### Restraining caps

Prevent joints to slide off the tubes during the assembly or readjustment of the mount.  
for L3D10 01.5993  
for L3D16 01.5994

### Cable management



#### Cable clips

Set of cable clips to keep cables organized along your mount. Easy to apply yet safe against inadvertent removal.

#### L3D set

14.0116

2x for L3D10, 3x for L3D16

#### Switch set

14.0110

6x for L3D10, 3x for L3D16

#### Floorstand set

17.0145

3x for M3D22, 2x for FS

#### M3D set

11.0122

5x for M3D22

#### Set of universal cable sleeves

14.0120

Set of 3 cable sleeves (3x 200mm - 3x 8") that can be wrapped around tubes with diameters 10, 16 or 22mm (3/8", 5/6" and 7/8") and can keep multiple cables with different thicknesses neatly organized along Rehadapt mounts.

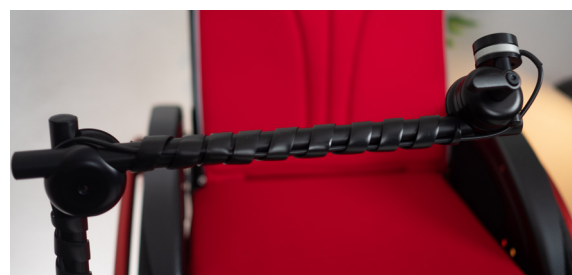

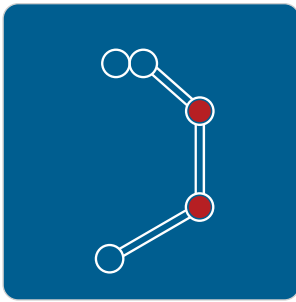

# Joints

Rehadapt's signature joints combine maximum strength and flexibility with very intuitive operation. They can connect all three types of Rehadapt tubes. All joints are available with different options like with Allen screws, QuickShift levers or with an extra screw for locking the tube while still allowing movement.

## Overview

Rehadapt's signature joints combine maximum strength and flexibility with very intuitive operation. They can connect all three types of Rehadapt tubes. All joints are available with different options like with Allen screws, QuickShift levers or with an extra screw for locking the tube while still allowing movement.

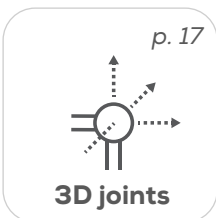

Full 360° adjustment in all dimensions

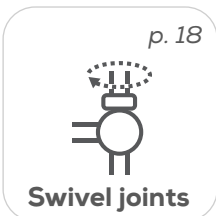

Swing your mounts between different positions



Connect tubes at a fixed angle



Move a device easily out of the way







Activation with a simple push button



## 3D joints

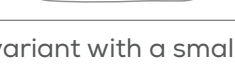

connecting different diameters	Screw <sup>1</sup>	Screw & lock <sup>2</sup>	QuickShift lever <sup>3</sup>	QS lever & lock <sup>4</sup>	
	M3D22 → M3D22	11.1300	11.1305	11.1350	11.1355
	M3D22 → L3D16	14.1203		14.1253	
	M3D22 → L3D10 <sup>#</sup>	14.1204		14.1264	
	L3D16 → L3D16	14.1200	14.1257	14.1250	14.1254
	L3D16 → L3D10 <sup>#</sup>	14.1201	14.1258	14.1251 <sup>*</sup>	14.1255
	L3D10 → L3D10 <sup>#</sup>	14.1202	14.1259	14.1252	14.1256

\*variant with a smaller lever for a smaller footprint (14.1271)



### <sup>1</sup>Screw

Adjusting the joint with an Allen bolt.



### <sup>2</sup>Screw & lock

Additional Allen bolt locks the tube's movement.



### <sup>3</sup>QuickShift lever

With additional QuickShift lever to adjust without tools.



### <sup>4</sup>QuickShift lever & lock

Additional QuickShift lever to adjust without tools and Allen bolt to lock the tube's movement.



### <sup>#</sup>Optional sleeves

Sleeve that allows a third party device adapter or tube with a smaller diameter to be clamped on L3D10 joints.  
for Ø 6 mm (15/64") 14.0106  
for Ø 8 mm (5/16") 14.0108



# Swivel joints

Our swivel joints let you easily swing the mount between predefined positions. Just open the QuickShift lever and lift the mount upwards. Due to the adjustable clamping force of the lever this can even be performed by the user himself.

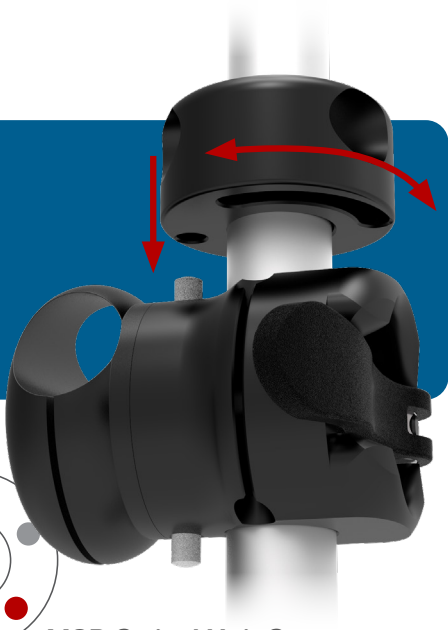

**M3D Swivel Unit**  
11.1210

- M3D22 to M3D22
- with indexing latch
- no locking mechanism



**M3D Swivel Unit S**  
11.1220

- M3D22 to M3D22
- with indexing slot
- backlash-free
- with QuickShift lever
- clamping force adjustable



**Replacement kit**  
11.1260  
for the swivel joint S (11.1220)  
with a tough steel lever.



**L3D Swivel Unit S**  
14.1220

- L3D16 to L3D16
- with indexing slot
- with QuickShift lever



**M3D Swivel Unit Swing Away**  
11.1230

Monty 3D swivel unit to be used with the swing away joint. Allows the mount to be detached and defines two latch positions "operating/exiting" and "parked".



**L3D Swivel Unit S 22**  
14.1222

- M3D22 to L3D16
- with indexing slot
- with QuickShift lever



**M3D Indexing Latch Swing Away**  
11.1255

Indexing clamp for using the M3D swivel unit S with a swing away joint. Defines two latch positions "operating/exiting" and "parked".

# Indexing slots

Swing the mount to three predefined positions: operating (1), exiting (2) and parking (3). Achieve this by either latching the pin into the desired position or sliding it smoothly through the slot.

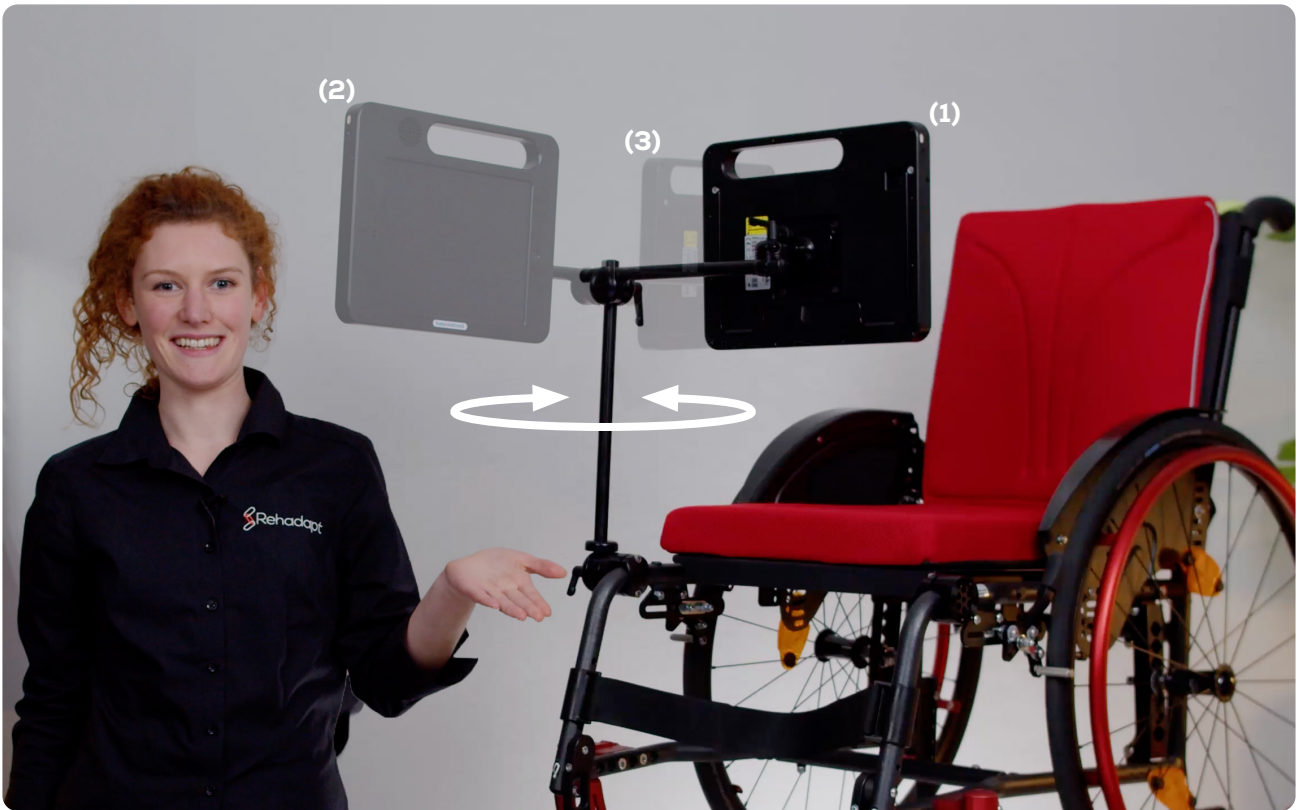

Three typical positions of a wheelchair mount: operating (1), exiting (2) and parking (3)

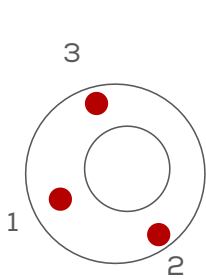

### Indexing-latch

Swing the mount to pre-defined positions by latching the pin into one of the three holes.



for M3D22 tube 11.1253

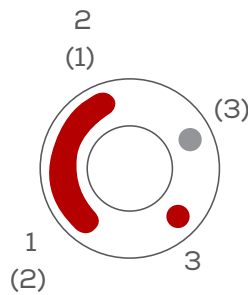

### Indexing-slot

Latching the pin into the parking position and slide smoothly between operating and exiting position.



for M3D22 tube 11.1251  
for L3D16 tube 14.1225

when mounted on the left side

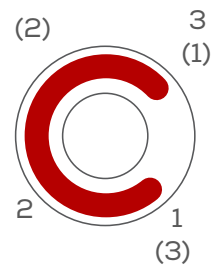

### Indexing-slot 270°

Slide the mount smoothly between operating, exiting and parking position.



for M3D22 tube 11.1254

## Folding joints



Fold down unit to move the device easily up and then to the side of the wheelchair. For use with M3D22 tubes.

Move a device easily out of the way for a quick exit option without detaching the mount.

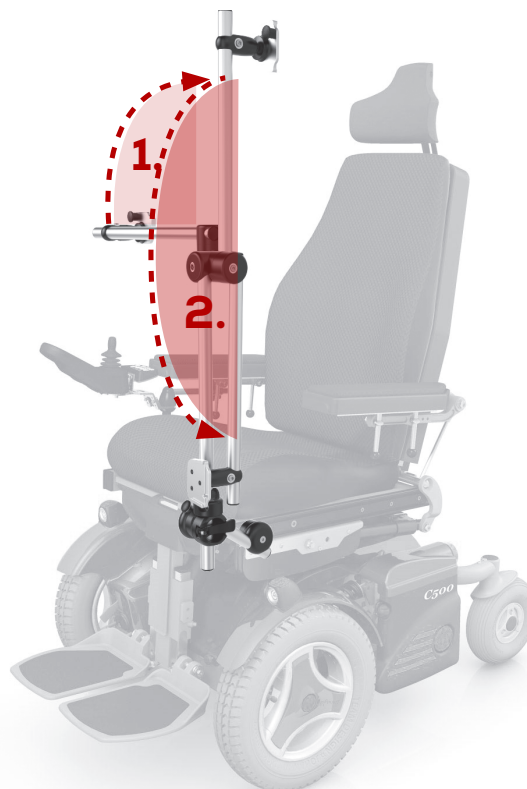

**Fold down unit  
for left side**  
11.1321

**Fold down unit  
for right side**  
11.1320

## Fixed joints

90°  
orthogonal

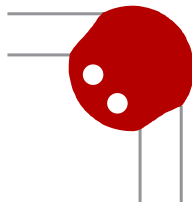

for M3D22 11.1390  
for L3D10 14.1303

65°  
acute-angled

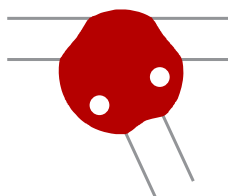

for M3D22 11.1330  
for L3D10 14.1302

0°  
parallel

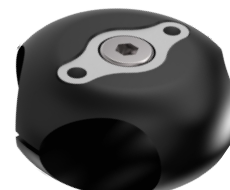

for M3D22 double-tube  
HD systems 11.1500

## Swing away joint

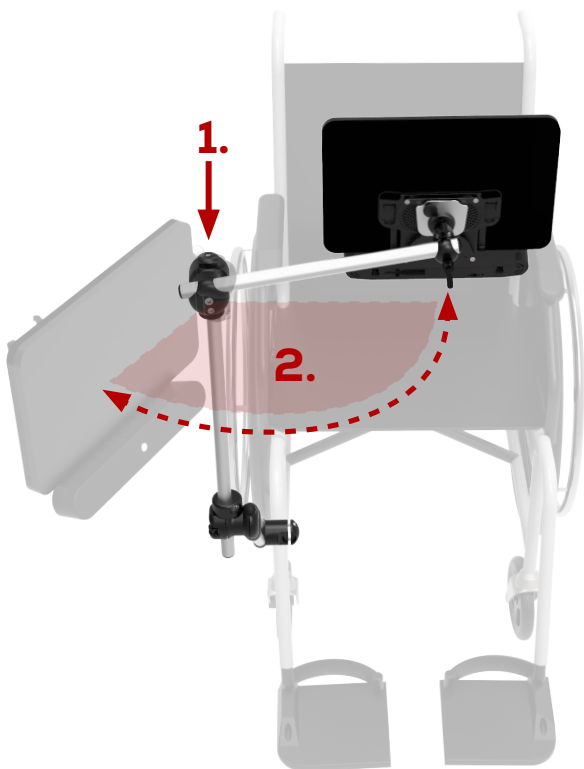

- Connects two M3D22 tubes
- Allows the device to swivel smoothly between two positions 110° apart
- Activation with the push of a finger
- Can be operated by the caregiver or the wheelchair user themselves

- Safety feature automatically locks in place when reaching either the operating or the entering/exiting positions
- Smooth bearing-driven mechanism
- Can be mounted on the left or the right side



The swing away unit was designed to give a whole new level of autonomy to the wheelchair user. With the simple push of a button, the mount can be effortlessly swung away to an optimal angle that allows the entering/exiting of the wheelchair.

This durable component has a sturdy construction and was designed to endure intense everyday use. Regardless, the bearing-driven mechanism will ensure a smooth movement every time.



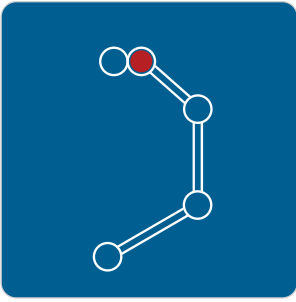

## Sockets

"The mother of all sockets" - our universal device socket (UDS) includes our quick release mechanism which allows for the safe device attachment within seconds. The footprint on the device is minimal, yet great sturdiness is achieved! Optional you can combine your existing mounting elements with Rehadapt's ecosystem with our system bridges.

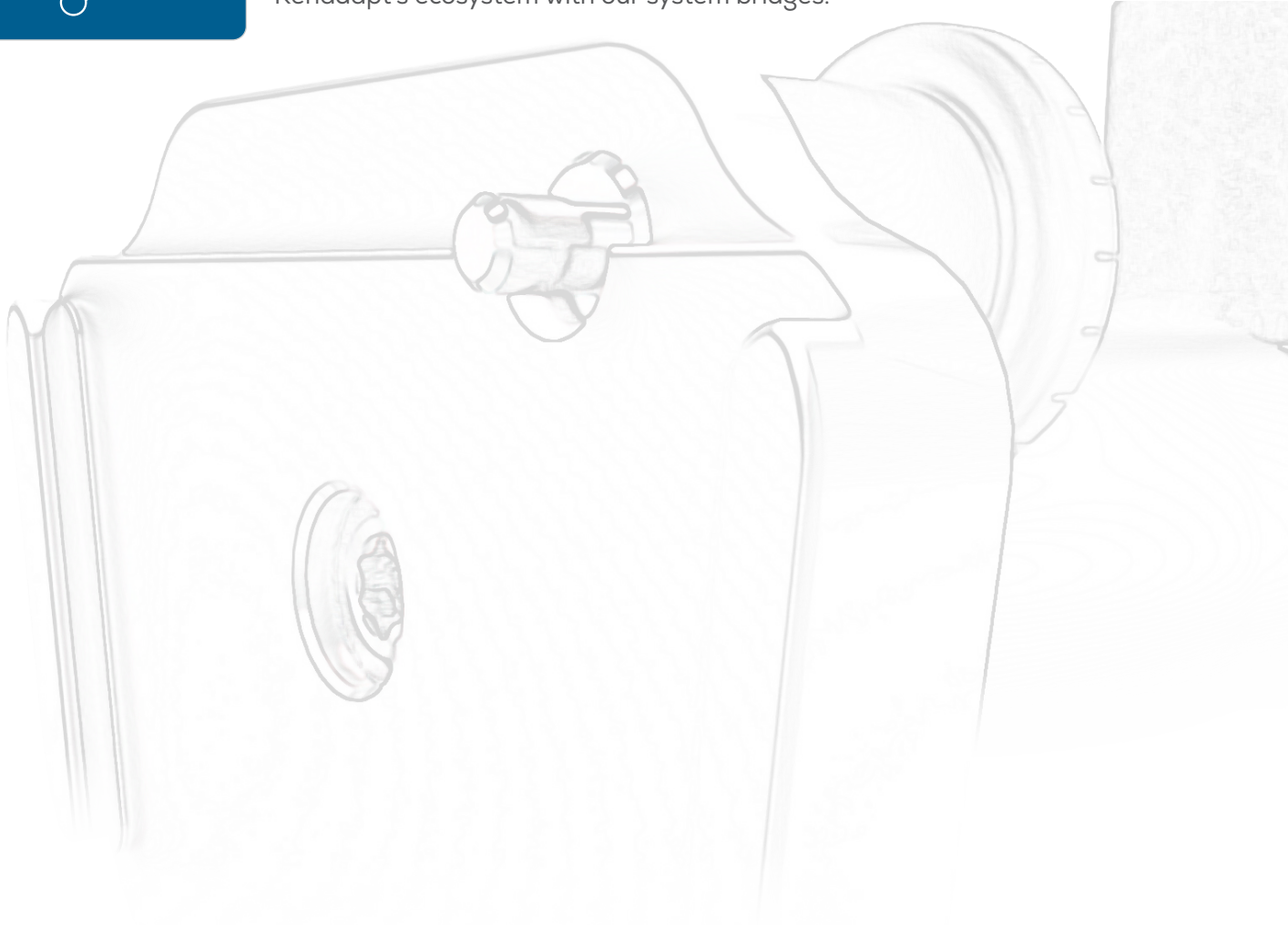

## System bridges



SLS → UDS  
14.1516



VESA → UDS  
16.1010  
Perfect for 3rd party monitor holders to carry devices with a Rehadapt UDS adapter plate.



UDS → Daessy  
16.1020



EyeGaze → Edge Talker  
16.1021



Edero arm support → M3D  
16.1022



Device adapter for mounting the Edero Arm Support from Armon on Rehadapt's Monty 3D system. Includes a pin for inserting the arm and a tube for parking it.

## Sockets

### UDS 22 DC 16.1051

Two levers for separated fixation of the ball joint and the tube clamp. This way, the weight of the device remains supported during repositioning.

The included bolts and Quickshift lever allow you to replace or optimize the existing fastening elements.

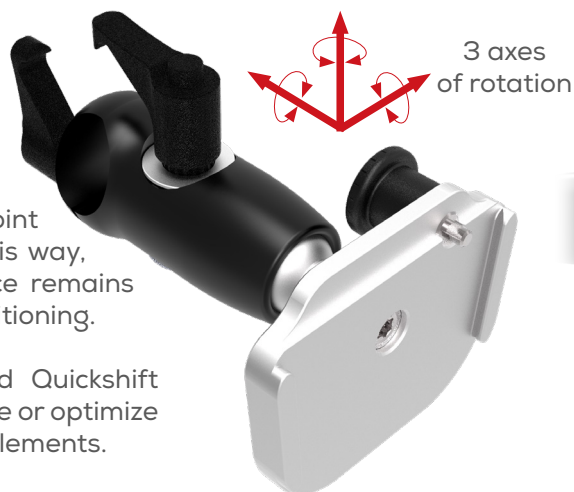

UDS 22  
16.1000

Fixation with a bolt



UDS 22 QS  
16.1050

Fixation with a lever

### UDS Eco Plus 16.1005



Excellent compromise between economic yet flexible use of Rehadapt's quick release system. Allows for the rotation around the tube axis and the twisting of the screen. Fastened with a bolt.

### UDS Eco 16.1004

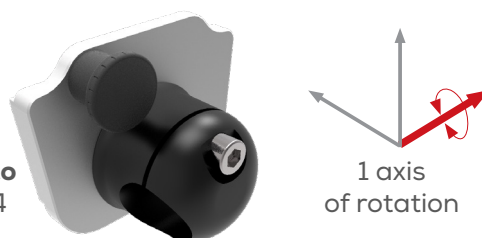

The most economic and compact version of Rehadapt's quick release system: sitting directly on the tube. Allows for the rotation around the tube axis. Fastened with a bolt.



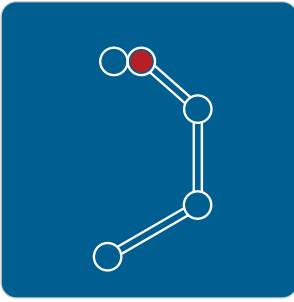

# Adapters

Rehadapt offers a wide range of adapters to fit onto any kind of communication device - no matter if it's a laptop, a smartphone or just a symbol book or pointing board. You can even combine different connection systems to integrate your existing mount within the Rehadapt ecosystem.

## Connection types

Adapters are permanently fixed to the device. This way you can attach and detach them easily with different release systems:



**UDS**  
Quickly hook them in and out of the universal device socket.



**SLS**  
Insert them into the spigot link system.

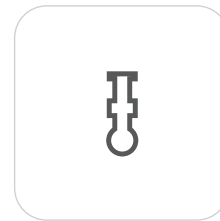

**MA**  
Screw them onto the MagicArm.

## Device types

Rehadapt subdivides the almost endless amount of devices to mount into three different types:

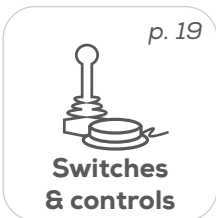

p. 19

**Switches & controls**

Light weight and small switches and joysticks.



p. 19

**Consumer devices**

Eye tracking and speech generating.



p. 19

**Communication devices**

Heavy weight and dedicated communication tools.

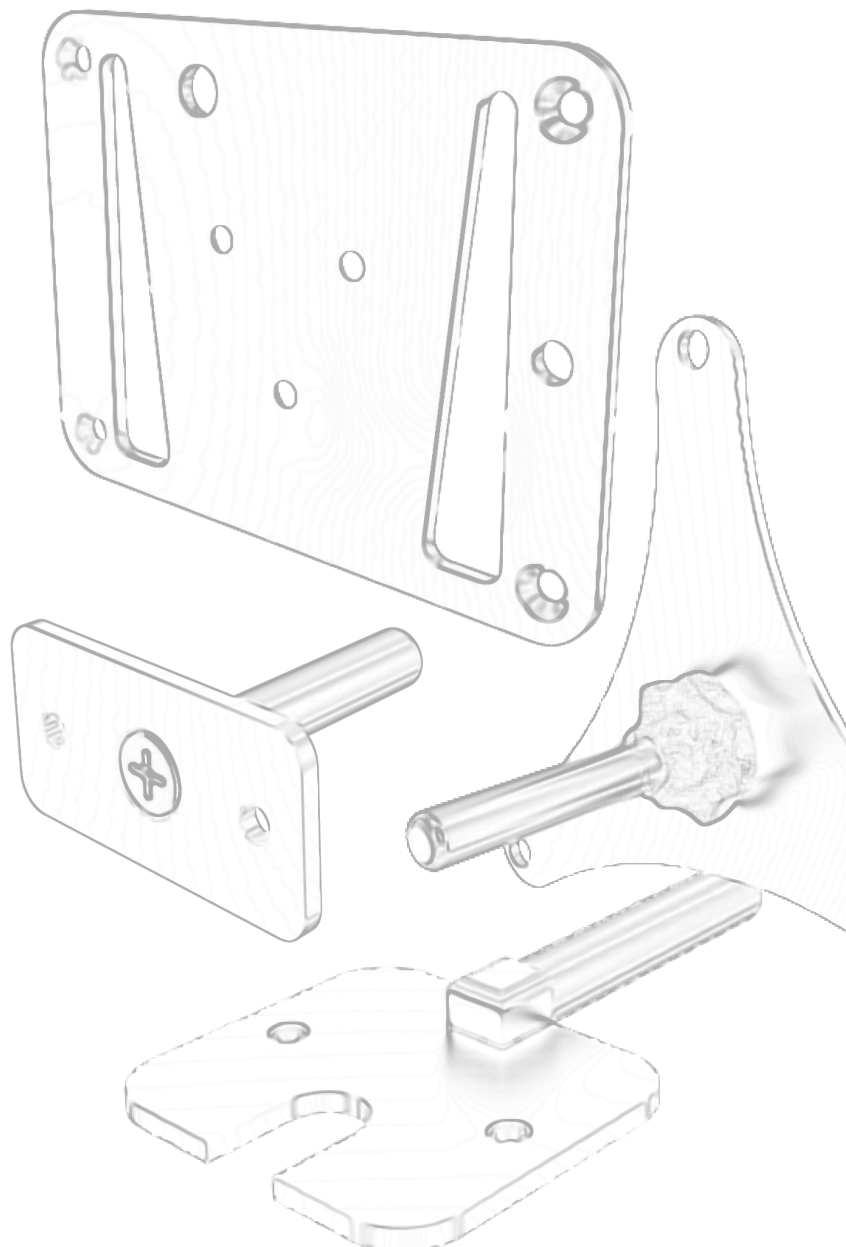

## For dedicated AAC devices

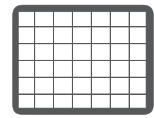

Communication devices



**Accent 800/1000**  
16.1150



**Accent 1400**  
16.1237



**Nova Chat**  
16.1144



**Nova Chat 8.2**  
16.1194



**Nova Chat 10.6**  
16.1236



**LC EyeGaze**  
16.1159



**LC EyeGaze Big**  
16.1216



**EyeGaze Edge**  
16.1197



**Tobii I-12+/I-15+/I-110**  
16.1168



**Zingui**  
16.1135



**GoTalk Express32**  
16.1134



**Tech/Talk 8 AMDi**  
16.1146



**Zingui 2**  
16.1206



**ProxTalker**  
16.1218



**Mobi 2**  
16.1138



**Tellus 5**  
16.1187



**GridPad**  
16.1177



**Lightwriter**  
SL40/45/50  
for UDS 16.1129



**Vibe 10 /  
Vibe 12 / Allora 3**  
16.1243



**Allora 2**  
16.1151



**AMDi Adapter**  
for UDS 16.1141  
with integrated  
kickstand 16.1184  
for SLS 14.1503



**GoTalk**  
**4+/9+/20+**  
for UDS 16.1221  
for SLS 14.1555



## Eye tracker brackets

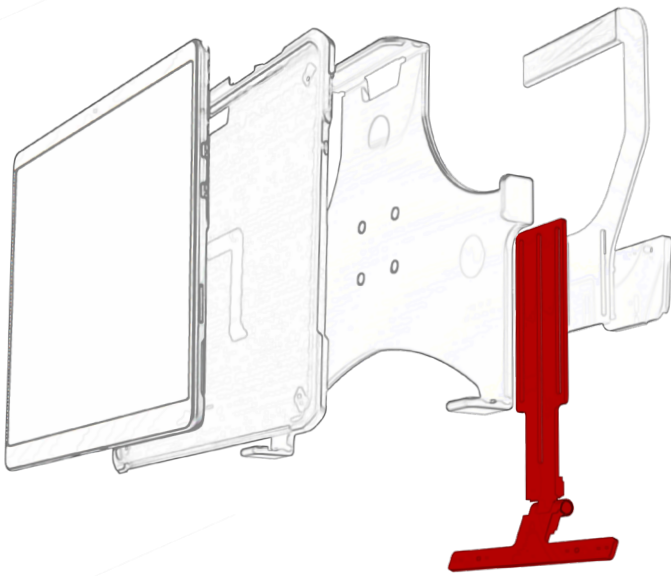

Device adapter for eye control cameras. Applicable to Tobii PCEye Mini, Tobii PCEye Go, Tobii PCEye Explore, Alea CAM NT30, MyGaze, MyGaze Power, EyeTech TM5 mini, EyeV and Irisbond Duo eye-tracking camera. Compatible with all of Rehadapt's tablet or notebook cradles, both with UDS or SLS interface. Also version for VESA hole pattern available.



**Irisbond Duo for  
Tellus 5**  
16.1234

**Alea  
CAM NT30**  
16.1145

**Irisbond Duo for  
Mobile Demand**  
16.1233

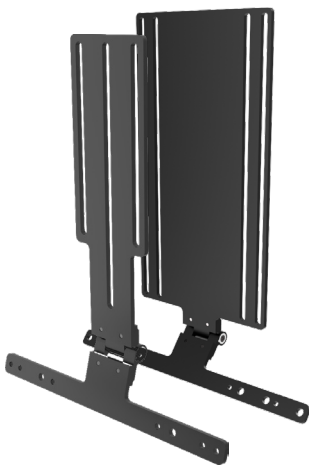

**EyeGaze Bracket**  
16.1193  
for VESA 16.1213

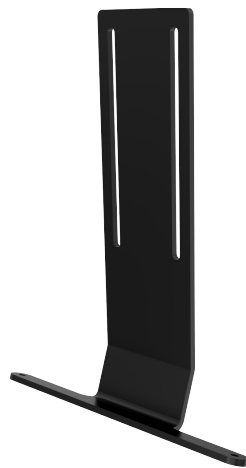

**Irisbond Huru**  
16.1239



**Irisbond Duo**  
16.1207  
for VESA 16.1232



**GA EyeV Skyle**  
16.1253

## Plan B



**Clipboard**  
16.1201



**Bookstand**  
16.1202

When the speech generating device is not available: mountable clipboard & bookstand to position the printed fallback communication tools.

# System bridges

## AMPS hole pattern

The AMPS hole pattern is an industry standard configuration. It consists of four holes located in a rectangular pattern spaced at 30,17 mm by 46,05 mm. It is common for the AMPS pattern to consist of multiple holes to allow vertical or horizontal implementation. For hand-held and tablet-sized devices. Many cradles, brackets and protective cases (e.g. LifeProof) use the AMPS system.



for UDS with M4 threaded holes  
16.1169



for SLS  
14.1546

## VESA hole pattern

The VESA standard has typically square hole patterns for flat panel displays. To combine with our Universal Device Socket (UDS).



for 75x75  
16.1117

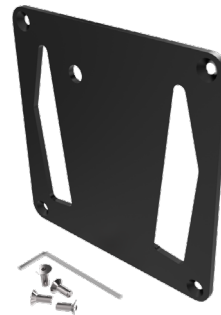

for 100x100  
16.1123

## Velcro fastener

The famous hook-and-loop Velcro fastener consists of two components: a lineal fabric strip with tiny hooks that could "mate" with another fabric strip with smaller loops, attaching temporarily, until pulled apart. Perfect for attaching devices to our mounting system when no screws can be used.

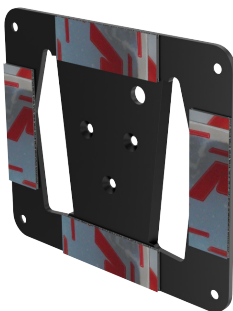

116x135 mm  
UDS 16.1148  
SLS 14.1512



110x50 mm  
SLS 14.1558

## Adhesive tape

Permanent fixation with strong adhesive tape. Perfect for attaching devices to our mounting system indefinitely when no screws can be used.



116x135 mm  
UDS 16.1147  
SLS 14.1511

## Rehadapt's Quick Release System

Device adapter plate for mounting devices on Rehadapt's Universal Device Socket (UDS). Compatible with the EyeGaze holder (#16.1193).



**Universal 70/50**  
16.1224

## Addons for AAC devices



**Phone Holder for  
Communication Aids**  
16.1240

Fits I-13/I-16 (Tobii Dynavox),  
Grid Pad 12/15 (Smartbox)

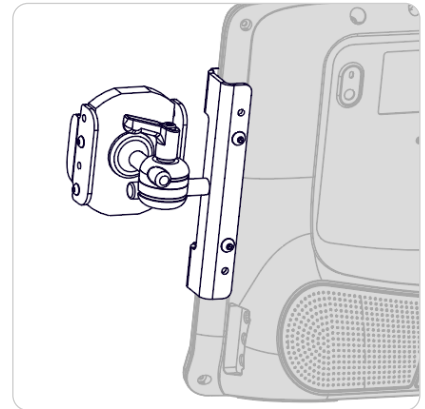

**omnicharge Powerbank**  
16.1235

Device cradle for mounting the omnicharge  
powerbank (model: Omni Mobile 25600  
PRO) on a M3D tube (Ø22mm – 7/8”).



## For 3rd party protective cases

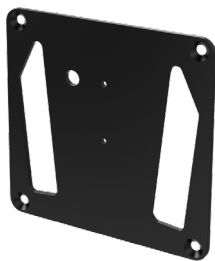

**VESA 100x100 aXtion**  
16.1244

for the aXtion cases with with bolted  
rotating from “The Joy Factory”



**Mobile Demand**  
16.1230

for the rugged xCases  
from “Mobile Demand”

## Laptop holder

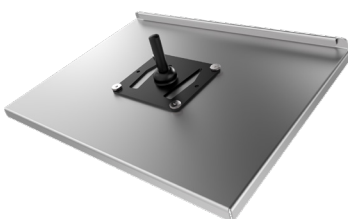

**Laptop Tray**  
420 mm x 315 mm  
for UDS 16.1163  
for SLS 14.1535





for laptops from 10” - 14”  
for UDS 16.1136  
for laptops from 15” - 17”  
for UDS 16.1140

## Cradles for Apple devices



Consumer devices

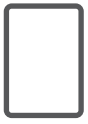

Device	Generation	without Otterbox		with Otterbox	
		UDS	SLS	UDS	SLS
 iPad	2 / 3 / 4	16.1133	14.1500	16.1158	14.1524
	5 / 6	16.1157	14.1514	16.1160	14.1526
	7 / 8 / 9	16.1231	14.1623	16.1215	14.1604
	10	16.1252	14.1593	16.1249	14.1592
 iPad Pro	1 (9.7")	16.1171	14.1545	16.1160	14.1526
	1 (10.5")	16.1214	14.1603	16.1215	14.1604
	1 / 2 / 3 / 4 / 5 (11")	16.1225	14.1611	16.1226	14.1612
	1 / 2 (12.9")	16.1188	14.1565	16.1196	14.1570
	3 / 4 / 5 / 6 (12.9")	16.1227	14.1613	16.1228	14.1614
 iPad Mini	1 / 2 / 3	16.1167	14.1519	16.1174	14.1551
	4 / 5	16.1198	14.1581	16.1222	14.1615
	6	16.1242	14.1627	16.1247	14.1630
 iPad Air	1	16.1157	14.1514	16.1160	14.1526
	2	16.1171	14.1545	16.1181	14.1559
	3	16.1214	14.1603	16.1215	14.1604
	4 / 5	16.1225	14.1611	16.1226	14.1612

## Cradles for other tablets

Device	Generation	without case		with Griffin Survivor		with UAG Metro-polis	
		UDS	SLS	UDS	SLS	UDS	SLS
Surface Pro	4 / 2017	16.1189	14.1566	16.1203	14.1589	16.1241	14.1626
	6 / 7	16.1189	14.1566			16.1241	14.1626
	8 / 9	16.1245	14.1628			16.1246	14.1629
Tab Tite	for 10" tablets	16.1180	14.1549				



## Universal holders

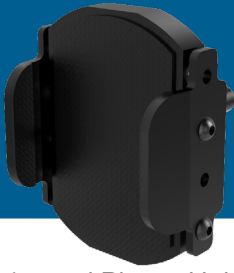

The **universal phone holder** was developed to accommodate any type of smartphone or phablet with or without a protective cover. The device is secured with two spring-loaded wings and rubber mats add friction and ensure non-slip surfaces. Its sleek design and durable materials ensure everlasting use.

Universal Phone Holder  
for SLS 14.1610

Finally, it can be set in two possible configurations:

- ✓ phone width 50-80mm (2" - 3")
- ✓ phone width 80-95mm (3" - 3 3/4")

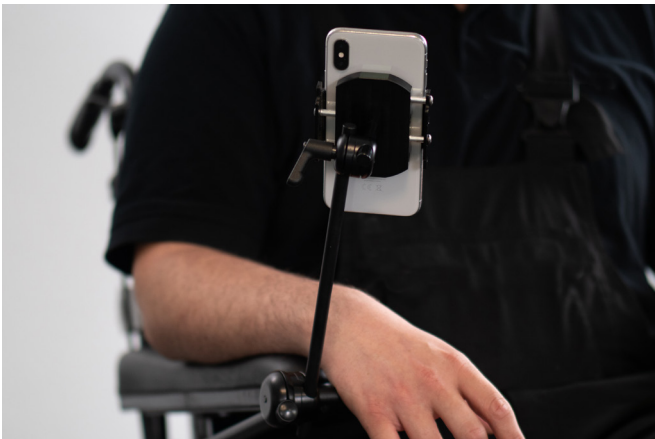

Universal Tablet Holder  
for UDS 16.1220  
for SLS 14.1622

With the **universal tablet holder**, virtually any tablet device can get integrated into the Rehadapt mounting ecosystem. Don't worry about the brand, the size, aspect ratio or even odd dimensions of a protective case: after a one-time adjustment to your individual specs, you can safely attach the tablet to any Rehadapt mount with the UDS interface.

- ✓ five adjustable holding points
- ✓ for 7" to 13" screen size
- ✓ for up to 36 mm (1 1/2") thickness
- ✓ device height 180 to 285 mm
- ✓ device width 230 to 375 mm

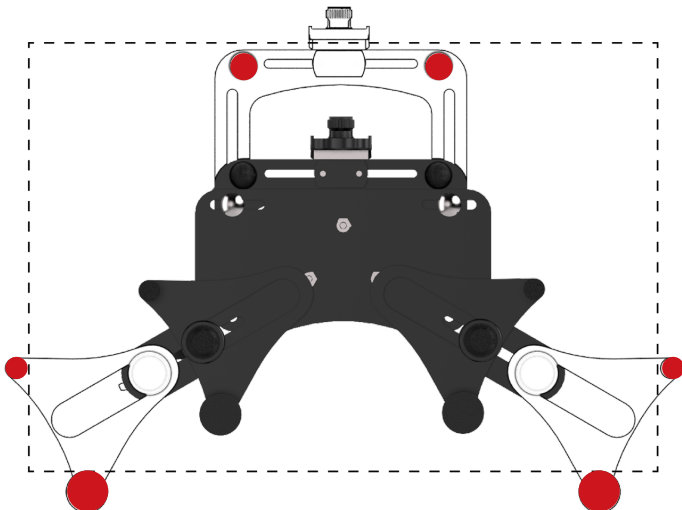

## See what is possible

No other mounting solutions on the market comes even close to this versatility! Our cradles for iPads and Surface Pros can be expanded with a number of accessories. We have cradles for all iPads and Surface Pros whether you use a protective case or not. Attach an eyetracker bracket or add a handle. All sorts of expansions are possible! And it can be amended with several add-ons:

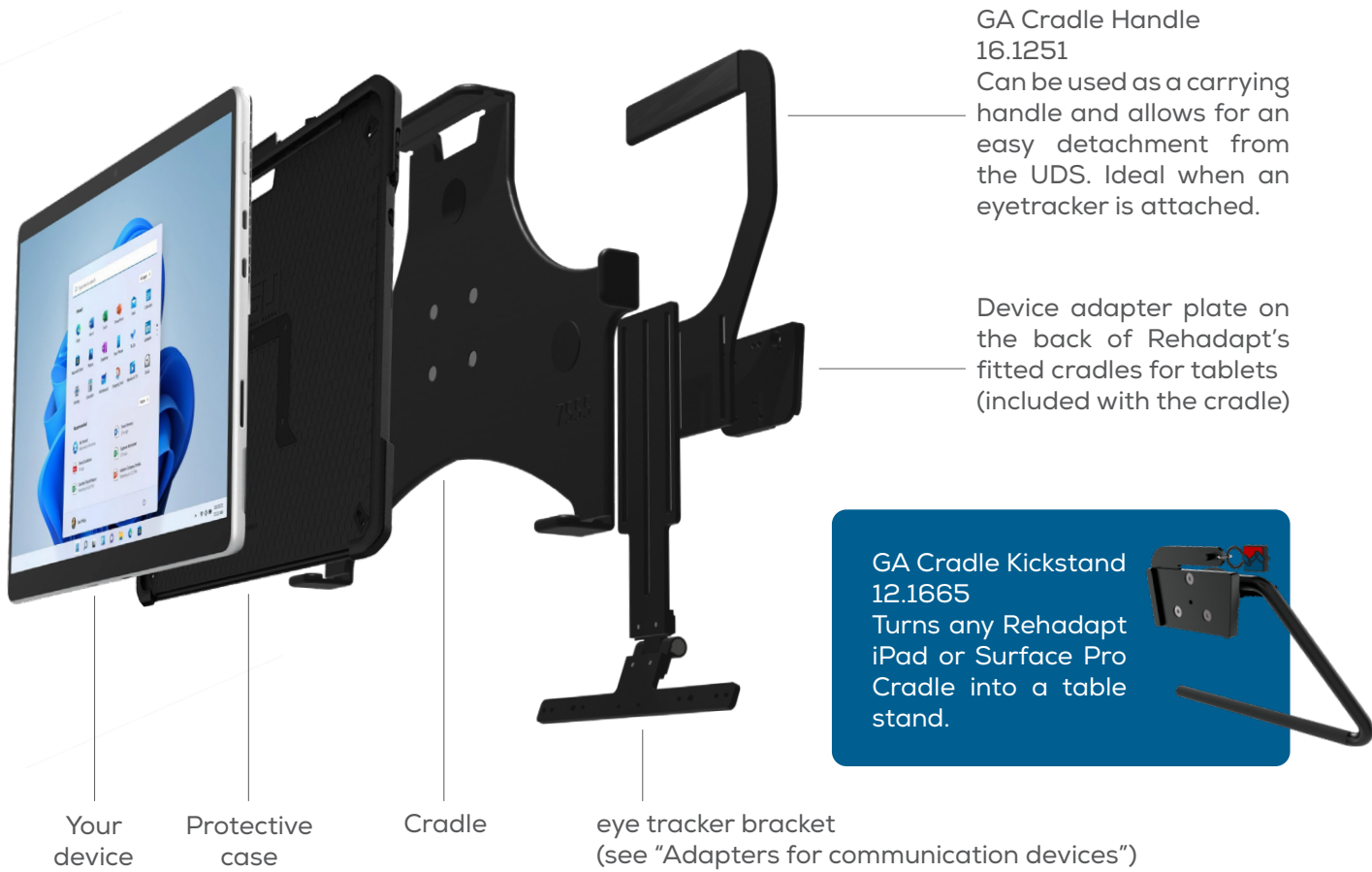

GA Phone Holder for Communication Aids  
16.1240

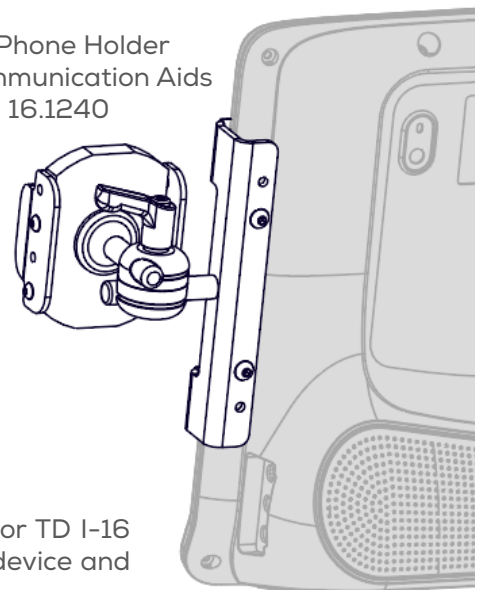

Holder for attaching any smartphone to the I-13, I-16, TD I-13 or TD I-16 or the Grid Pad 12 or 15. Clamps to the right or left side of the device and accommodates any type of smartphone.

## For dedicated switches



Switches  
& controls



**AbleNet Jelly Bean**  
14.1506



**Piko Button**  
14.1582



**AbleNet Big Red**  
14.1507

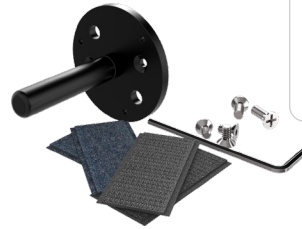

**Buddy/Specs/Little Candy Corn/Orby**  
14.1508

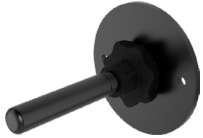

**Lib/Freedom/Aero**  
14.1509



**James/AMDi PartnerPlus(4)/  
WobbleSwitch/Step-by-Step**  
14.1583



**Egg Switch**  
14.1624



**Micro Light Switch**  
14.1573

## For dedicated joysticks



**REM 550/420 joystick**  
14.1618



**A368 joystick**  
14.1619



**G690a BKT joystick**  
14.1620



**P & G joystick**  
14.1621



**DX G91 joystick**  
14.1616



**Pilot 2 joystick**  
14.1605



**REM 24 joystick**  
14.1617



**Zoom HD  
Heavy joystick**  
14.1529



**VersaGuide/Compact/  
All-round joysticks**  
14.1575



**Omni joystick**  
14.1504



**Omni Control IF**  
14.1528



**Omni 2 Control IF**  
14.1606



**Omni 2 Control IF Flex Back**  
14.1625

## For environmental controls

---



**GEWA  
One/Connect**  
14.1594



**L3D GA CSS AssistX  
Mobil Call System**  
14.1636



**UB45**  
for 1/4" UNC threads  
14.1563

## For universal use

---

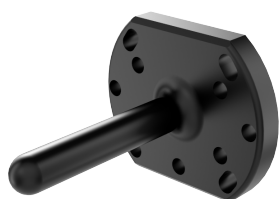

### L3D Universal Adapter

Device adapter with 10 mm (14.1530) or 16 mm (14.1531) Spigot Link System (SLS) for mounting on Rehadapt's L3D system. Suitable for the backrest controls from Hidrex, Switch It and Stealth Products, among others.



**AKL M6**  
for holes  $\varnothing$  6 - 8 mm ( $\frac{1}{4}$ " -  $\frac{1}{3}$ ")  
14.1587



**L3D GA 3/8"-UNC**  
for 3/8" UNC threads  
14.1591



**Tube  $\varnothing$ 10-50**  
for 1/4" UNC threads  
14.9511\_SW

## For use with a joint

---

These adapters include a joint for mounting onto 10 mm (3/8") Rehadapt's L3D system.



**AbleNet Mini joystick**  
14.1584



**Proximity Sensor**  
14.1585



**AbleNet pneumatic switch**  
14.1586





## For use with wheelchair structure

Adapter tubes to be attached to different wheelchair spots. With 16 mm or 10 mm pins for connecting a L3D universal joint.

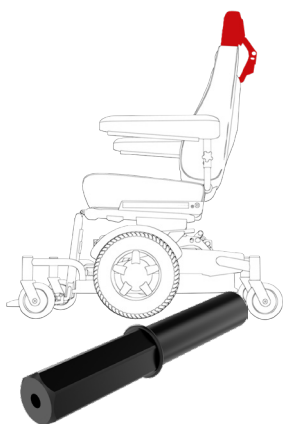

**Headrest Meyra**  
with 16 mm pin  
14.1184

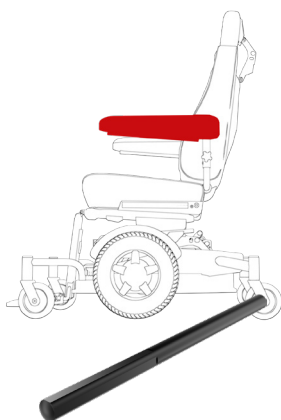

**Armrest Meyra**  
with 10 mm pin 14.1574  
with 16 mm pin 14.1183

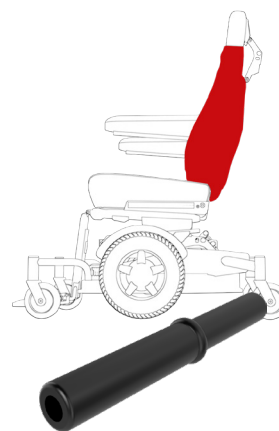

**Seat back Vassilli**  
with 16 mm pin  
14.1182

## For gaming

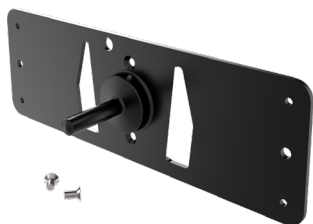

**Xbox Adaptive Controller**  
with SLS 14.1590

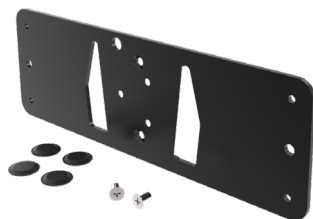

**Xbox Adaptive Controller**  
with UDS 16.1219

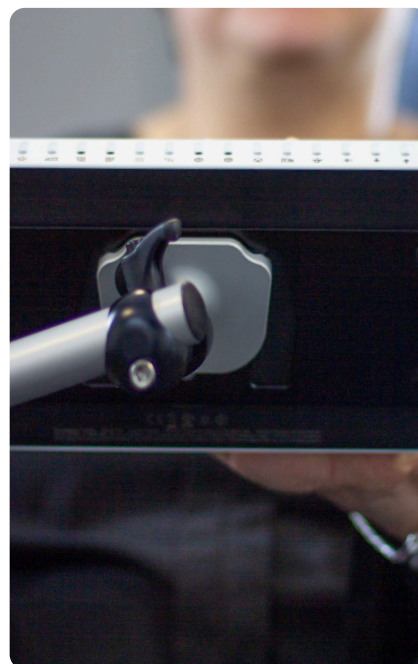



## Tools

### Allen Wrench

tools with t-handle option in different diameters and lengths:

5 mm with T-handle 01.0027  
5 mm with longer shaft 01.0008



Standard-lengths:

2 mm	01.0034
2.5 mm	01.0035
3 mm	01.0002
4 mm	01.0029
5 mm	01.0014

5/64"	01.0638
3/32"	01.0436
1/8"	01.0657
7/32"	01.0437

### Slot Screwdriver 5x100 01.0435



**Assembly tool**  
01.0037  
for widening the  
clamping gap

## Measuring



**Folding Yardstick**  
01.0045  
with riveted lock joints.  
Metric and imperial  
system. Overall length:  
2m (78")

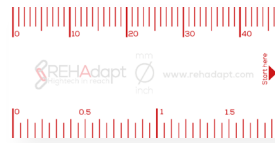

**Post-It**  
00.4016  
to measure the dia-  
meter of tubes in both  
millimeters and inches.  
Maximum tube diame-  
ter: 46mm (1 13/16").



**Digital Caliper**  
01.0032  
Carbon fiber caliper  
with a digital display.  
Measurement range:  
0-150mm (0-6"). Accu-  
racy: ±0.1mm.



**T-nut gauge set**  
01.0600  
To be inserted in the  
T-nut profile and easily  
identify the correct  
fitting Rehadapt frame  
clamp

## Consumables



**OKS 250 Lubricant 8ml**  
04.0012  
to be applied on bolts and achieve the optimum tightening torque while protecting the threads from corrosion



**Alcohol wipes**  
01.0078  
for cleaning and disinfecting surfaces. Appropriate for cleaning Rehadapt's joints and tubes.

“With Rehadapt you are not on your own. Through our wide range of services, you’ve got a dedicated team at your side.”



Your communication device deserves the perfect mount and you deserve superior service. We analyze your **individual** needs to provide you with the best **mounting solution**. For free!



Obtain professional tools and expert training to serve your clients with profound positioning and mounting skills. We are happy to share our knowledge and transfer mounting expertise to the field through **on-demand videos, online trainings or workshops**.



Rehadapt wants to **increase the lifetime of products** and provide support for its clients even after the 5 year limit which is specified by law through the Medical Device Regulation. Maintenance in the RSC facilitates the usage of products until the end of their true service time. Furthermore we offer structured **maintenance documents** for correctly reviewing Rehadapt mounting solutions.

Learn more on [rehadapt.com](http://rehadapt.com) and feel free to get in touch with us!

We  your feedback



Be our driving force to improve your Rehadapt experience!

[rehadapt.com/we-love-your-feedback](http://rehadapt.com/we-love-your-feedback)



Download this catalog and further information here:

[rehadapt.com/downloads](http://rehadapt.com/downloads)